

SONY

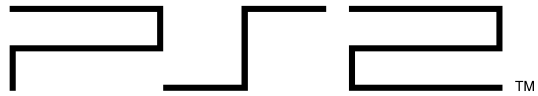

PlayStation 2



Instruction Manual

Thank you for purchasing the PlayStation®2 computer entertainment system. Before using this product, carefully read this manual and retain it for future reference.

使用說明書

感謝您購買 PlayStation®2 電腦娛樂系統。使用本機以前，請先詳細閱讀本說明書，並妥善保存，以備將來參考之用。

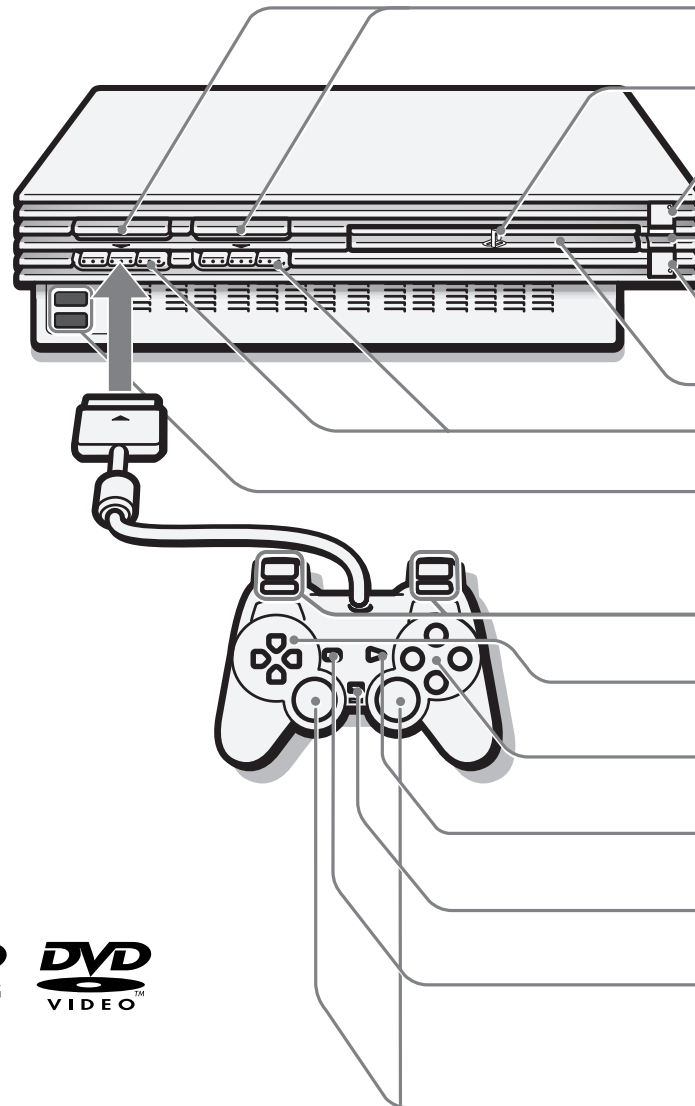

GB English	CT 中文
MEMORY CARD slots	MEMORY CARD (記憶卡) 插口
"PS" product family logo	"PS" 家族企業標誌
⏻ (standby)/RESET button and ⏻ indicator	⏻ (預備)/RESET (再啟動) 按鈕和 ⏻ 顯示燈
IR receiver	紅外線接收器
⏻ (open) button and ⏻ indicator	⏻ (打開) 按鈕和 ⏻ 顯示燈
Disc tray	光碟托盤
Controller ports	控制器端子
USB connectors	USB 連接埠
L2 button, R2 button, L1 button, R1 button	L2 按鈕, R2 按鈕, L1 按鈕, R1 按鈕
Directional buttons	方向按鈕
△ button, ○ button, × button, □ button	△ 按鈕, ○ 按鈕, × 按鈕, □ 按鈕
START button	START (開始) 按鈕
ANALOG mode button	ANALOG (類比) 方式開關
SELECT button	SELECT (選擇) 按鈕
Left analog stick, right analog stick, L3 button, R3 button	左類比操作桿, 右類比操作桿, L3 按鈕, R3 按鈕



SCPH-55006 GT



WARNING

To prevent fire or shock hazard, do not expose the unit to rain or moisture.

To prevent fire or shock hazard, do not place a container filled with liquids on top of the console.

To avoid electrical shock, do not open the cabinet. Refer servicing to qualified personnel only.

Caution

The use of optical instruments with this product will increase eye hazard. As the laser beam used in this unit is harmful to eyes, do not attempt to disassemble the cabinet.

Refer servicing to qualified personnel only.

Read carefully before operating your PlayStation®2 console

A few people may experience epileptic seizures when viewing flashing lights or patterns in our daily environment. These persons may experience seizures while watching TV or playing video games, including DVD videos or games played on the PlayStation®2 console. Players who have not had any seizures may nonetheless have an undetected epileptic condition. Consult your physician before operating the PlayStation®2 console if you have an epileptic condition or experience any of the following symptoms while watching TV programs or playing video games: altered vision, muscle twitching, other involuntary movements, loss of awareness of your surroundings, mental confusion, and/or convulsions.

Some PlayStation® format software titles may perform differently on the PlayStation®2 console than they did on the PlayStation® console, or may not perform properly on the PlayStation®2 console. For more information, call the PlayStation® service line number listed on your warranty card for technical assistance.

Precautions

Safety

This product has been designed with the highest concern for safety. However, any electrical device, if used improperly, has the potential for causing fire, electrical shock or personal injury. To help ensure accident-free operation, follow these guidelines:

- Observe all warnings, precautions and instructions.
- Stop use immediately if the device functions in an abnormal manner, or produces unusual sounds or smells.
- Never connect cables of types other than those specified in this manual to the line connector.
Connect only cables of the proper type for each connector.
- If the device does not operate properly, call the PlayStation® service line number listed on your warranty card for technical assistance.

Use and handling

- Do not throw or drop the console or subject the item to strong physical shock.
- Do not place the console on surfaces that are unstable, tilted or subject to vibration.
- Never move or change the position of a console while it is turned on.
- Do not expose the console to high temperatures, high humidity or direct sunlight (use in an environment where temperatures range 5°C – 35°C).
- Do not place the console in locations subject to sudden temperature change (e.g. temperature changes of 10°C per hour or more).
- Do not leave the console in a car with its windows closed (particularly in summer) as this may warp the product exterior or cause the product to malfunction.
- Do not use the console in a dusty location.
- Do not allow liquid or small particles to get into the console.
- Do not place the console close to magnetic fields such as those produced by magnets, loudspeakers or television sets.
- Do not put heavy objects on the console.
- Do not touch the metal parts or insert foreign objects into the connectors of the console.
- When you do not intend to use the console for an extended period of time, disconnect the power plug for the PlayStation®2 console from the electrical outlet.
- When disconnecting the power plug from an electrical outlet, pull it out by grasping the plug. Never pull the cord itself.
- Do not place any rubber or vinyl materials on the exterior of the console for an extended period of time. Doing so may damage the plastic surface.
- To help prevent eye strain, take a break of about 15 minutes during every hour of play.
- Use only the supplied AC power cord.
- Unplug all cords and cables before moving the console.

Checking the AC power cord

To help ensure safe operation of this product, regularly inspect the AC power cord for wear and tear. If the cord is damaged, discontinue use immediately and call the PlayStation® service line number listed on your warranty card for technical assistance.

Do not touch the connectors on the console

Do not touch the metal parts of, or insert foreign objects into, the connectors on the console.

Do not expose the console to cigarette smoke or dust

When setting up the PlayStation®2 console, avoid places subject to excessive cigarette smoke or dust. Cigarette smoke residue or dust build-up on internal components such as the lens, may cause the console to malfunction.

Cleaning the vents

Dust can accumulate in both the front and rear vents of the PlayStation®2 console. Check the vents from time to time and remove any accumulated dust with a low-powered vacuum cleaner.

Disc handling

- Do not leave discs near a heat source, in direct sunlight, or in high humidity.
- Store discs in their cases when they are not being used. Stacking discs or standing them at an angle without putting them in their cases can cause the discs to warp.
- Do not touch the disc surface when handling a disc; hold it by the edges.
- Do not stick paper or tape onto the disc.
- Do not write on the disc with a marker, etc.
- Fingerprints, dust, dirt or scratches on the disc can distort the picture or reduce sound quality. Always handle carefully and make sure discs are clean before use.
- Clean discs using a soft cloth, lightly wiping from the center outwards.
- Do not use solvents such as benzene, commercially available cleaners not intended for CDs or anti-static spray intended for vinyl LPs as these may damage your disc.

Moisture condensation

If the console or the disc is brought directly from a cold location to a warm one, moisture may condense on the lens inside the console or on the disc. Should this occur, the console may not operate properly. In this case, remove the disc and do not put the disc back in until the moisture evaporates. (This could take several hours.)

If the console still does not operate properly, call the PlayStation® service line number listed on your warranty card for technical assistance.

Cleaning the console

For safety reasons, before cleaning the console, 1) turn off the PlayStation®2 console using the main power switch on the console rear and 2) disconnect the power plug from the electrical outlet.





- Do not use paint thinner, solvents or other chemicals to clean the exterior of the console, as these may damage the surface. When using a commercially available cleaning cloth, follow the instructions supplied with the cloth.
- If the exterior of the console becomes dirty, soak a soft cloth in a mild detergent solution diluted with water, tightly squeeze the cloth to remove the excess liquid, wipe the affected area of the exterior, and finish by wiping with a dry cloth.



Never disassemble the console

- Use your PlayStation®2 console according to the instructions in this manual. No authorization for the analysis or modification of the PlayStation®2 console, nor the analysis and use of the product's circuit configurations, is provided.
- There are no user-serviceable components inside the PlayStation®2 console. Disassembling the console will void the warranty. Additionally, there is a risk of exposure to laser radiation as well as to electrical shock hazards.

Notes on safety when using the analog controller (DUALSHOCK®2)*

- Stop using the console immediately if you begin to feel tired or if you experience discomfort or pain in your hands or arms while operating the analog controller (DUALSHOCK®2). If the condition persists, consult a doctor.
 - The analog controller (DUALSHOCK®2) is intended for use with the hands only. Do not bring it into close contact with your head, face or the bones of any other part of the body.
 - The vibration function of the analog controller (DUALSHOCK®2) can aggravate injuries. Do not use the vibration function if you have any ailment or injury to the bones, joints or muscles of your hands or arms. Note that some PlayStation®2 and PlayStation® format software titles set the vibration function to "On" by default. In most cases, the vibration function can be set to "Off" in the options menu of the software. Do not play such titles using the analog controller (DUALSHOCK®2) unless you have set the vibration function to "Off".
 - Avoid prolonged use of the analog controller (DUALSHOCK®2). Take a break at about 30 minute intervals.
- * These notes also apply to the analog controller (DUALSHOCK®).

	PlayStation®2 format DVD-ROM	PlayStation®2 format CD-ROM	PlayStation® format CD-ROM
Disc logo	"  ", PlayStation®2 logo and  designation	"  ", PlayStation®2 logo and  designation	PlayStation® logo and  designation
Disc color	Silver	Blue	Black
Contents	Audio and video		
Disc size	12 cm		

	Audio CDs		DVD videos ^{*3}		DVD-RW (VR mode)	
Disc logo						
Contents	Audio		Audio and video		Audio and video	
Disc size	12 cm	8 cm ^{*1}	12 cm	8 cm ^{*2}	12 cm	8 cm ^{*2}



The "DVD VIDEO" and "DVD-RW" logos are trademarks.

*1 When you position the console vertically and play an 8 cm audio CD, use an optional adaptor.

*2 When playing an 8 cm DVD video or DVD-RW disc, always place the console in the horizontal position.

*3 The term "DVD videos" refers to DVD-VIDEO, DVD-R, DVD+R, DVD+RW discs as well as DVD-RW discs recorded in Video mode.

DVD video systems and regional restrictions

- This console conforms to the NTSC broadcast standard. You cannot play discs recorded for other broadcast standards (such as PAL or SECAM) on this console.
- Some DVD VIDEOS are marked with region numbers such as . The number contained within the symbol represents the region number of DVD players on which the disc can be played. DVD VIDEOS that do not bear this symbol, or that do not display the number 3 cannot be played on your console.
- DVD VIDEOS with the  label can also be played on this console. If you attempt to play any other DVD VIDEOS, a message stating "This disc cannot be played due to regional restrictions" will appear on the screen.
- Some DVD VIDEOS that have no region code markings may still be subject to area restrictions and may not be playable on the console.

Notes on the playback of DVD-R/DVD-RW/DVD+R/DVD+RW discs*

Some discs recorded using DVD-R/DVD-RW/DVD+R/DVD+RW devices may not be playable due to scratches, dirt, dust, fingerprints or problems encountered during recording, or due to the state of the disc when the recording was made. Only discs that have been finalized (a process that concludes recording) after recording are playable. Video recorded on CPRM (Content Protection for Recordable Media) compatible DVD-RW discs using the copy-once capability, will not play that section of video, and the message "Playback is restricted. Cannot play." will be displayed. For details, refer to the instructions supplied with the DVD recording device. (CPRM is a copy protection system with scramble capability for recorded "copy-once" broadcast programs.)

* For details on each type of DVD media, refer to the Glossary on page 28 of this instruction manual.

Irregularly shaped discs

Do not use irregularly shaped CDs or DVDs (for example, heart- or star-shaped discs) as they may cause the console to malfunction.

Notes on playback operations of DVD video

- This console plays back DVD video as originally designed by the software producers. Some of the playback features of this console may not have been incorporated into the DVD video design. As a result some playback features may not be available with certain software. Refer to the instructions supplied with your DVD video for details.
- In rare instances, certain DVD videos may not operate properly with PlayStation®2. This is primarily due to variations in the manufacturing process or software encoding of the DVD video software. If you experience problems, try restarting your DVD video. If problems persist, for more information call the publisher of the DVD video or contact the PlayStation® service line number listed on your warranty card for technical assistance.

	WARNING	2	
	Precautions	2	
	Discs that can be played with the PlayStation®2 console	3	
	Getting started		
	Checking the package contents	4	
	Part names	5	
	Positioning the console	5	
	Connection		
	Connecting your console to a TV set	6	
	Connecting digital audio equipment	7	
	Connecting other digital equipment	8	
	Using the main menu	8	
		Playing a game	10
		Using memory cards	12
Games / Audio CDs			
Playing an audio CD		12	
		Playing a DVD video	14
	DVD videos		
	Settings and adjustments for the DVD player	19	
	Troubleshooting	26	
	Specifications	28	
	Additional information		
	Glossary	28	
	WARRANTY	29	



Check that you have the following items:

- PlayStation®2 console

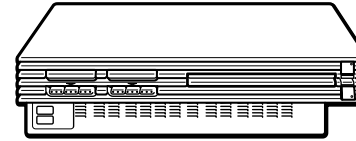

- Analog controller (DUALSHOCK®2)

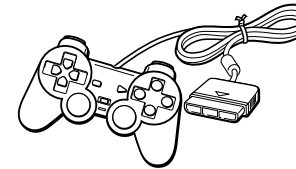

- AV cable (integrated audio/video)

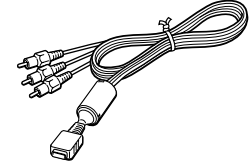

- AC power cord with the 3-pin converting adaptor attached

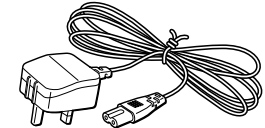

- Instruction manual (1 set)
- GRAN TURISMO 4 "Prologue" (1)

Removing the 3-pin converting adaptor

The socket outlet varies depending on where you use your PlayStation®2. If the plug of the supplied AC power cord does not match the socket outlet, remove the converting adaptor.

- 1 Loosen the screw.
- 2 Open the converting adaptor.

3-pin converting adaptor

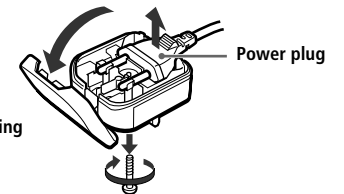

If any items are missing, contact our technical support line number listed on your warranty card for assistance.

PlayStation®2 console

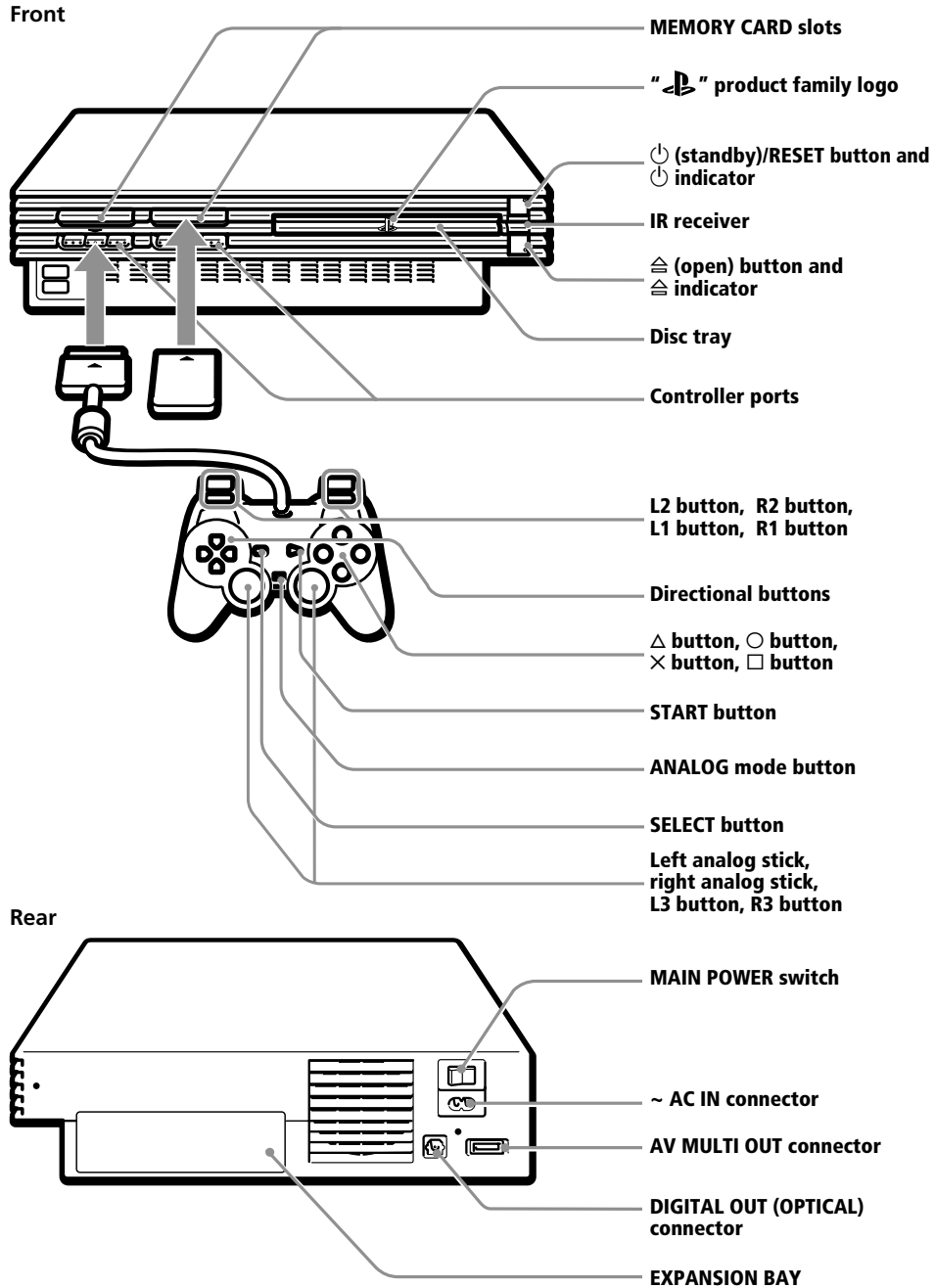

You can position the console either horizontally or vertically.

When positioning the console vertically, use the SCPH-10040 G vertical stand (for PlayStation®2) (sold separately). If a vertical stand (for PlayStation®2) is not available, set the console in the horizontal position as shown below.

When positioning the console horizontally, you can use the SCPH-10110 G horizontal stand (for PlayStation®2) (sold separately).

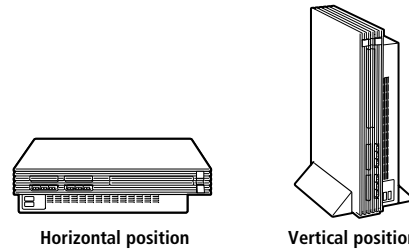

The "PS" product family logo on the disc tray

The "PS" product family logo on the disc tray can be rotated to match the horizontal or vertical positioning of the console.

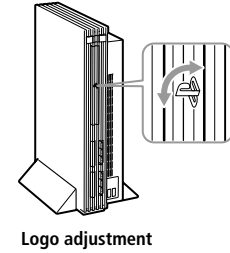

Notes

- Do not place the console in any position other than the horizontal or vertical positions as doing so may damage it.
- Do not change the position of the console while it is in operation. Doing so may damage the disc or cause the console to malfunction.

6 Connecting your console to a TV set

You can connect the PlayStation®2 console to most TVs or VCRs using the supplied AV cable (integrated audio/video) as described below. The console can also be connected to other types of TVs using specialized cables and adaptors, which are sold separately. For details, see the following sections:

- Connecting to a TV with an S VIDEO input connector (this page)
- Connecting to a TV with component video input connectors (page 7)

The instructions in the above sections assume audio output through TV speakers.

Caution

For safety reasons, turn off the console and remove the power plug from the electrical outlet before making or adjusting connections.

Note

If the picture quality is reduced when using progressive scan with a TV that supports progressive scan, try viewing in standard interlace mode. For details on progressive mode, see "Progressive" on page 22.

Connecting to a TV with audio/video inputs

Connect your PlayStation®2 console to the TV using the supplied AV cable (integrated audio/video). When connecting, match the color-coded cords to the appropriate jacks on the components: yellow (video) to yellow, red (right audio) to red and white (left audio) to white.

After connecting

Set your TV to the appropriate video input mode. Refer to the instruction manual supplied with your TV for details.

When connecting to a wide screen TV (16:9 aspect ratio)

Set "Screen Size" in the System Configuration menu to "16:9." For details on the System Configuration menu, see pages 8-9.

If your TV is monaural

Do not connect the red plug. If you want to hear both left and right sounds from a monaural TV, use a commercially available dual phono to single phono (stereo to monaural) type audio cable (sold separately).

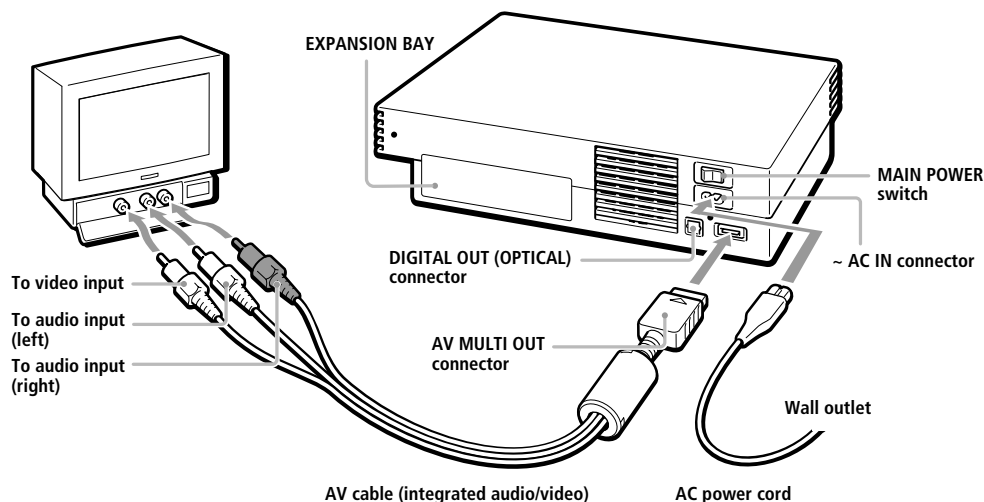

Connecting to a VCR

Connect your PlayStation®2 console to the VCR using the supplied AV cable (integrated audio/video) matching the plug colors.

If your VCR is monaural, do not connect the red plug. However, when playing a DVD video, do not connect the console to a VCR. If you do, picture quality may be reduced. Connect the console directly to the TV.

After connecting

Set your TV and VCR adjustments appropriately.

Refer to the instruction manuals supplied with your TV and VCR for details.

When playing a DVD video

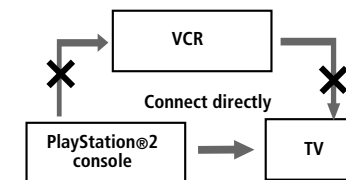

Connecting to a TV with an S VIDEO input connector

Connect your PlayStation®2 console to the S VIDEO input connector on the TV using the SCPH-10060 G S VIDEO cable (sold separately). You will get a better picture than when using the AV cable (integrated audio/video).

After connecting

Set your TV to the appropriate video input mode (such as "S VIDEO").

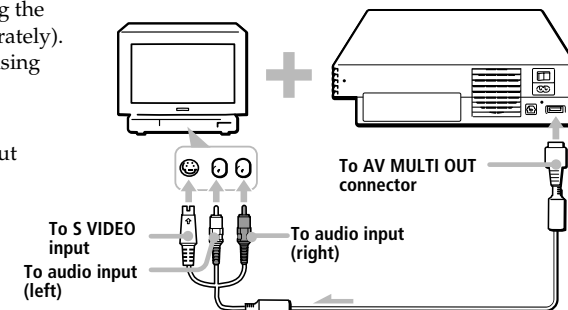

Connecting to a TV with component video input connectors

If your monitor or projector has component video input connectors (Y, C_B/P_B, C_R/P_R), connect your PlayStation®2 console using the SCPH-10100 G component AV cable (for PlayStation®2) (sold separately). This will provide the best picture.

Before connecting

If you connect your PlayStation®2 console to a television using the component AV cable without first setting the "Component Video Out" option under the System Configuration menu to "Y Cb/Pb Cr/Pr," the TV screen might not display properly. Before connecting your console with the component AV cable, first use the supplied AV cable (integrated audio/video) and make sure that the "Component Video Out" option is set to "Y Cb/Pb Cr/Pr."

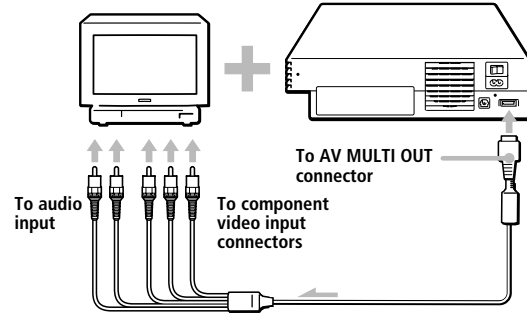

Notes

- The PlayStation®2 console is not compatible with HDTV unless the proper software and connecting cables are used. Refer to the instruction manual supplied with your TV for details.
- You must use the component AV cable to view DVD video in progressive scan. If picture quality is reduced when using progressive scan, try viewing in normal (interlace) mode. For details, see "Progressive" on page 22.

Do not connect your PlayStation®2 console to a projection TV

Static, non-moving images, such as DVD menus, configuration displays or paused images may leave a faint image permanently on the TV screen if left on for extended periods of time.

Projection TVs, except those of LCD screen types are more susceptible to this than other types of displays. Do not operate the console in such a manner that this could occur. Refer to the instruction manual supplied with your TV for details.

Note about bouncing effect

Some TVs or monitors may experience a bouncing effect in their pictures when using the PlayStation®2 console. There is nothing wrong with the PlayStation®2 console or the way it is manufactured. The problem technically lies within the television. If you encounter such a problem with your television/monitor, please contact our technical support line listed on your warranty card for technical assistance.

This section explains how to connect the PlayStation®2 console to audio equipment with digital connectors (such as Dolby Digital optical (AC-3) output). Using digital receivers and amplifiers, you can enjoy features such as multi-channel sound and surround sound.

Connecting to a receiver or amplifier, "MD (Minidisc)" deck or "DAT (Digital Audio Tape)" deck with a digital connector

Use a commercially available optical digital cable (sold separately) and set "DIGITAL OUT (OPTICAL)" in the System Configuration menu to "On" (the default setting).

For details on the System Configuration menu, see pages 8-9.

PlayStation®2 console rear

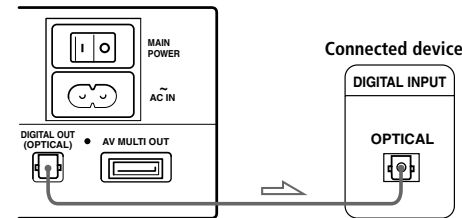

Notes

- Refer also to the instructions supplied with the device to be connected.
- You cannot directly make digital audio recordings of discs recorded in Dolby Digital format DTS or MPEG AUDIO format using an MD or a DAT deck.

Connecting to an audio device with a built-in DTS^{*1} Dolby Digital^{*2} or MPEG decoder (DVD video only)

By connecting to audio equipment with a built-in DTS Dolby Digital or MPEG decoder (sold separately), you can play back sound recorded on DVD videos in Dolby Digital (AC-3) DTS or MPEG AUDIO format to reproduce the effect of listening in a movie theater or concert hall.

Connect the device through the DIGITAL OUT (OPTICAL) connector using an optical digital cable (sold separately).

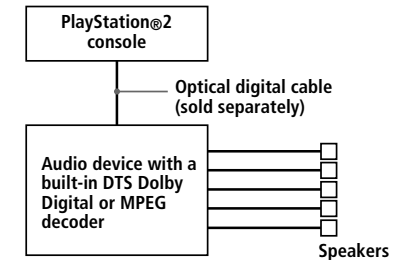

Settings for the DVD player on your PlayStation®2 console

You may need to adjust settings for the DVD player depending on the devices to be connected.

For details on using the Setup display, see pages 20-25.

- When you connect an audio device with a built-in DTS decoder**
Set "DIGITAL OUT (OPTICAL)" to "On" and then set "DTS" to "On" in the "Audio Setup" display.
- When you connect an audio device with a built-in Dolby Digital decoder**
Set "DIGITAL OUT (OPTICAL)" to "On" and then set "Dolby Digital" to "On" in the "Audio Setup" display.
- When you connect audio equipment with a built-in MPEG decoder**
Set "DIGITAL OUT (OPTICAL)" to "On" and then set "MPEG" to "On" in the "Audio Setup" display.

Note

Refer to the operating and setup instructions for the audio device to be connected.

*1 "DTS" and "DTS Digital Out" are trademarks of Digital Theater Systems, Inc.

*2 Manufactured under license from Dolby Laboratories. "Dolby" and the double-D symbol are trademarks of Dolby Laboratories. Confidential unpublished works. ©1992-1997 Dolby Laboratories. All rights reserved.

Connecting a device using the Universal Serial Bus (USB) interface

The two USB connectors on the front of the console can be used to connect USB-compatible devices. Also refer to the instructions supplied with the device to be connected.

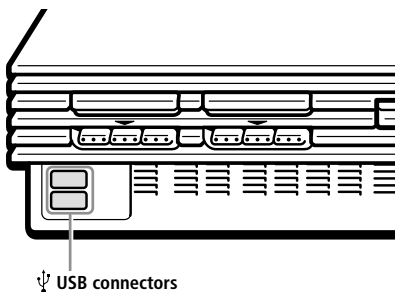

Note

Not all USB-compatible products work with the PlayStation®2 console. See the appropriate USB-compatible product's user manual for more information.

When you turn on the console for the first time you will be prompted to adjust basic language and time settings. These settings can be changed later through the System Configuration menu. For details, see "Using the System Configuration menu" (pages 8-9). After setup, the main menu is displayed whenever you turn on the console without a disc inserted.

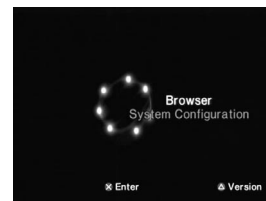

You can move to the Browser screen or the System Configuration menu from the main menu.

Using the Browser screen

You can do the following operations using the Browser screen:

- Check/copy/delete game data on the memory card (8MB) (for PlayStation®2) or memory card
- Start PlayStation® or PlayStation®2 format software
- Play an audio CD
- Play a DVD video

Select "Browser" using the directional buttons and press the X button.

The Browser screen is displayed. The memory card (8MB) (for PlayStation®2), memory card or disc inserted in the console are displayed as icons.

Checking/copying/deleting data

You can copy data from one memory card (8MB) (for PlayStation®2) or memory card to another or delete data you no longer wish to keep. You cannot, however, copy data of the PlayStation®2 format software to an SCPH-1020 HI memory card.

Insert the memory card (8MB) (for PlayStation®2) or memory card in advance.

- 1 Select the icon of the memory card (8MB) (for PlayStation®2) or memory card where the data you want to check/copy/delete is saved, and then press the X button.
- 2 Check/copy/delete data according to the instructions on the screen.

Note

While copying or deleting data, do not remove the memory card (8MB) (for PlayStation®2) or memory card.

Using the System Configuration menu

Using the System Configuration menu, you can change or update your system settings for the PlayStation®2 console.

Changes to these settings are saved and remain in effect even after you turn off the console. The default settings are underlined.

- 1 Select "System Configuration" using the directional buttons and press the X button.
The System Configuration menu is displayed.
- 2 Select the item you want using the directional buttons and press the X button.

■ Clock Adjustment

Sets the clock.

- 1 Use the directional buttons to set the month and then press the right directional button.
Use the same method to set the day, year, hour, minute and second. To return to the previous menu, press the left directional button.
- 2 Press the X button to start the clock.

Select optional settings for the clock

Select "Clock Adjustment" using the directional buttons and press the Δ button. You can set the following optional items.

Time Format

- 12 hour clock
- 24 hour clock

Date Format

- MM/DD/YYYY
- DD/MM/YYYY
- YYYY/MM/DD

Time Zone

Select the appropriate time zone.

Daylight Savings Time (Summer Time)

Set this item to "Daylight Savings Time (Summer Time)" when daylight savings time is in effect.

- Standard (Winter Time)
- Daylight Savings (Summer Time)

Screen Size

Selects the display mode according to the TV to be connected.

- 4:3 : Select this when you connect a standard TV to the console.
- Full : Select this when you connect a standard TV to the console. The black margins on the upper and lower portions of the screen are cut off.
- 16:9 : Select this when you connect a wide-screen TV to the console.

DIGITAL OUT (OPTICAL)

Selects whether to output signal through the DIGITAL OUT (OPTICAL) connector.

- On : Select this when you connect with an optical digital cable (sold separately). Normally select this option.
- Off : Select this when you do not want sound signal to be output via the DIGITAL OUT (OPTICAL) connector.

Component Video Out

If your TV, monitor or projector has an RGB input connector or component video input connectors (Y, C_B/P_B, C_R/P_R) that conform to the output signals of the console, set this item. When connecting the console using the supplied AV cable (integrated audio/video) or S VIDEO cable (sold separately), you do not need to set this item.

- Y C_B/P_B C_R/P_R : Select this when you connect the console to the component video input connectors.
- RGB : Select this when you connect the console to the RGB input connector.

Notes

You can output PlayStation® and PlayStation®2 format software in either RGB or Y C_B/P_B C_R/P_R format. However, the PlayStation®2 console has been designed to override the "Component Video Out" setting in the System Configuration menu and output all DVD video software in Y C_B/P_B C_R/P_R.

Remote Control

Set this option when using the DVD remote control (for PlayStation®2) which is sold separately.

- **Gameplay Function On:** Select this when operating PlayStation®2 or PlayStation® format software using the DVD remote control.
- **Gameplay Function Off:** Select this when not operating PlayStation®2 or PlayStation® format software using the DVD remote control.

Notes

- When Remote Control is set to "Gameplay Function On", some PlayStation®2 or PlayStation® format software may stop operating normally when a controller is removed from controller port 1. Set to "Gameplay Function Off" if this happens.
- Operation using the DVD remote control buttons may not work in some cases. Also, the DVD remote control will not work when you press two or more buttons at the same time.
- Some unlicensed 3rd party peripherals may not work with "Gameplay Function" set to "On". Note that the use of such peripherals is not recommended and will void your warranty.

Language

Selects the language for the on-screen display.

- English
- Traditional Chinese

Checking version information

You can check version information or settings of various features.

At the main menu, press the Δ button.

The Version Information screen is displayed.

The default settings are underlined.

Auto-diagnosis

The PlayStation®2 console automatically adjusts its internal settings for best possible disc playback.

However, when auto-diagnosis is set to "On" the console makes additional adjustments that may allow discs that were previously unplayable to be played.

Diagnosis

- Off
- On

1 Select "Console" using the directional buttons and press the Δ button.

2 Select "On" using the directional buttons and press the \times button.

3 Insert a disc.

The console automatically starts the diagnosis.

Notes

The diagnosis setting automatically returns to "Off" (default setting) when you press the O /reset button or start playing a PlayStation® format disc, PlayStation®2 format disc or a DVD video disc.

PlayStation® Driver

The PlayStation® Driver is a program for loading PlayStation® format software.

Disc Speed

- Standard: Normally select this position.
- Fast: Loading time for a PlayStation® format software disc can be shortened. Depending on the software, there may be no effect or the software may unexpectedly fail. In this case, select "Standard."

Texture Mapping

- Standard: Normally select this position.
- Smooth: You can make the display smoother when playing certain PlayStation® format software titles. Depending on the software, there may be no effect. In this case, select "Standard."

1 Select "PlayStation® Driver" using the directional buttons and press the Δ button.

2 Select the item you want using the directional buttons and press the \times button.

Notes

Adjusted settings automatically return to "Standard" (default setting) when you press the O /reset button or turn off the console.

Clearing the Progressive setting

You can clear the DVD player's Progressive setting.

Clear Progressive Setting

- No
- Yes

1 Use the directional buttons to select "DVD player", and press the Δ button.

2 Press the \times button.

3 Use the directional buttons to select "Yes" and press the \times button.

The Progressive setting is not cleared immediately after it is turned off. The setting will only be cleared when the DVD video starts playback.

4 Press the O button to return to the main menu. Then use the directional buttons to select "Browser", and press the \times button.

5 Use the directional buttons to select the DVD video icon, and press the \times button.

The DVD player's Progressive setting is cleared, and playback begins.

Notes

- This setting can be cleared only when "Progressive" is set to "On". When "Progressive" is set to "Off", the Options menu under DVD Player is not displayed.
- For details on setting "Progressive" to "On", see "Progressive" under "Settings and adjustments for the DVD player" on page 22.
- The progressive setting is not cleared if any of the following occur before step 5 is completed:
 - The console enters standby mode after the O (standby)/reset button has been pressed.
 - The console is turned off using the main power switch on the console rear.



Starting a game

- 1 Turn on the console using the main power switch on the console rear.
The $\text{\textcircled{P}}$ (standby) indicator on the console front lights up in red to indicate that the console is now in standby mode.
- 2 Press the $\text{\textcircled{P}}$ (standby)/reset button.
The $\text{\textcircled{P}}$ indicator turns green and the start-up screen is displayed.
- 3 Plug the analog controller (DUALSHOCK®2) into a controller port of the console.

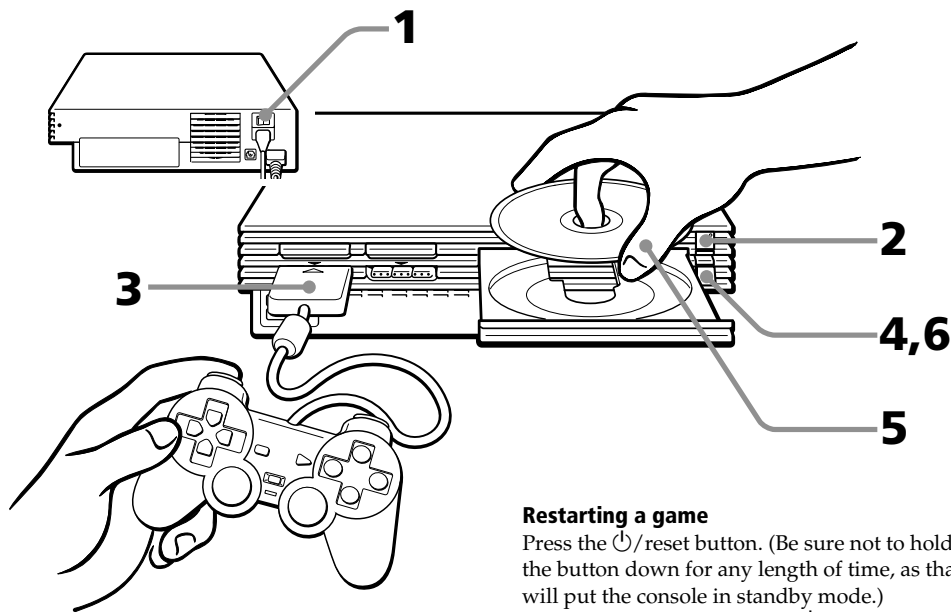

- 4 Press the $\text{\textcircled{O}}$ (open) button.
The disc tray opens.
- 5 Place a disc on the disc tray with the label side facing up (data side down).
- 6 Press the $\text{\textcircled{O}}$ button.
The disc tray closes. Screen ② or ③ is displayed and the game is ready to begin.

Note

Set the analog controller (DUALSHOCK®2) to the appropriate mode for the software (see “Mode switching and the mode indicator” on page 11). Refer to the appropriate software manual for details.

Restarting a game

Press the $\text{\textcircled{P}}$ /reset button. (Be sure not to hold the button down for any length of time, as that will put the console in standby mode.) Do not accidentally press the $\text{\textcircled{P}}$ /reset button while playing a game, or the game will restart.

Screens that appear at start-up

When turning on the console without first inserting a disc

Screen ① is displayed.

- When you insert a PlayStation®2 or PlayStation® format disc after screen ① has appeared, screen ② or ③ will be displayed and you can start the game.
- You can move to the Browser screen or the System Configuration menu from screen ①. (For details, see “Using the main menu” on page 8.)

When turning on the console with a disc already inserted

Depending on the type of disc inserted, screen ②, ③ or ④ will be displayed.

If screen ④ is displayed, it is possible that the inserted disc is not a PlayStation® or PlayStation®2 format disc. Check the disc type (page 3).

- ① No disc is inserted (main menu).

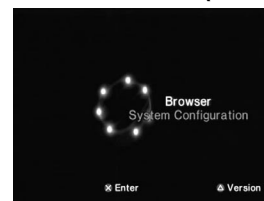

- ② PlayStation®2 format DVD-ROM / CD-ROM is inserted.



- ③ PlayStation® format CD-ROM is inserted.



- ④ A disc that cannot be played with the PlayStation®2 console is inserted.



Ending a game

- 1 Press the $\text{\textcircled{O}}$ (open) button.
The disc tray opens.
- 2 Remove the disc.
- 3 Press the $\text{\textcircled{O}}$ button.
The disc tray closes.
- 4 Press the $\text{\textcircled{P}}$ /reset button for more than three seconds.
The $\text{\textcircled{P}}$ indicator turns red and the console enters standby mode.

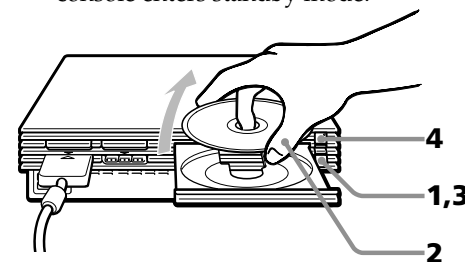

When not intending to play a game for an extended period of time

Turn the power off at the main power switch on the console rear, disconnect the power plug from the electrical socket.

Changing from one game to another

There is no need to turn off the console when you want to change games.

1 Press the (open) button.

The disc tray opens.

2 Remove the disc.



3 Place a new disc in the disc tray.

4 Press the button.

The disc tray closes.

5 Press the (standby)/reset button to reset.

(**Note:** holding the /reset button down for any length of time may cause the console to go into standby mode.)

After the start-up screen, screen  or  is displayed and the game begins.

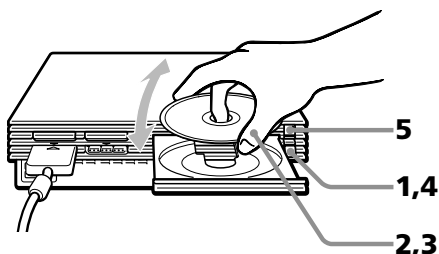





Note

With a multi-disc game, follow steps 1 through 4 to switch discs. Refer to the software manual for details.

Using the analog controller (DUALSHOCK®2)

- The analog controller (DUALSHOCK®2) can be used with PlayStation®2 and PlayStation® format software.
- You can switch between digital and analog modes. When the controller is in analog mode, the following buttons and sticks may operate in analog fashion depending on the features supported by the software title. Refer to the software manual for details.

PlayStation®2 format software

Directional buttons, , , ,  buttons, left analog stick, right analog stick, L1, R1, L2, R2 buttons

PlayStation® format software

Left analog stick / right analog stick

- You can use the vibration function.

Using the analog controller (DUALSHOCK®) (sold separately)

- The analog controller (DUALSHOCK®) can also be used with PlayStation®2 and PlayStation® format software.

- You can switch between digital and analog modes. When in analog mode, you can enjoy the analog operation of the left analog stick and right analog stick.

PlayStation®2 format software

Left analog stick / right analog stick

PlayStation® format software

Left analog stick / right analog stick

- You can use the vibration function.

Mode switching and the mode indicator

The analog controller (DUALSHOCK®2) can be switched between two modes by pressing the analog mode button.

Each time the analog mode button is pressed, the mode changes as follows:

Digital mode (indicator: off)



Analog mode (indicator: red)

Note

Switch to the appropriate mode for use.

Note, however, that some software makes this adjustment automatically. In such cases, the analog mode button is overridden by the software. For details, refer to the software manual.

Vibration function

The analog controller (DUALSHOCK®2) features a vibration function when the function is supported by the software title. The vibration function can be set to ON or OFF on the software option screen.

Notes

- When the analog controller (DUALSHOCK®2) is not being used, turn the console off or unplug the controller from the console.
- Before using the vibration function, please read "Notes on safety when using the analog controller (DUALSHOCK®2)" on page 3.

Before using the analog controller (DUALSHOCK®2)

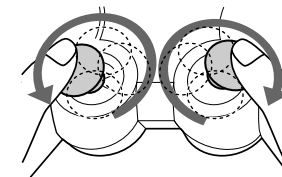

After turning the console on, rotate the left and right analog sticks once with your thumbs before starting a game. Do not twist the analog sticks, but rotate as if drawing a circle as shown in the diagram above.

Digital mode (indicator: off)

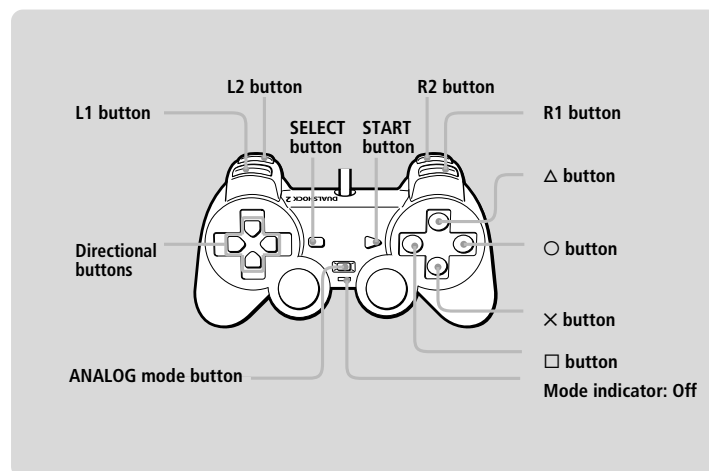

Analog mode (indicator: red)

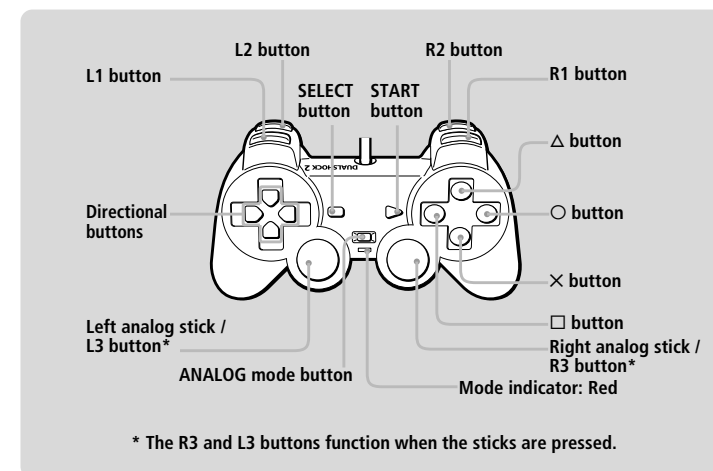

You can save and load game or other data using the memory card (8MB) (for PlayStation®2) or memory card (each sold separately).

Differences between the memory card (8MB) (for PlayStation®2) and memory card

When playing PlayStation®2 format software, use the memory card (8MB*) (for PlayStation®2) (①).
When playing PlayStation® format software, use the memory card (②).

For the PlayStation® game console, units of game data are described as “memory blocks,” however for the PlayStation®2 console, they are described as “KB” (kilobytes).

* 8 MB = 8,000 KB

① Memory card (8MB) (for PlayStation®2) (sold separately)

The memory card (8MB) (for PlayStation®2) can save and load PlayStation®2 format software game data. Each memory card (8MB) (for PlayStation®2) can save about 8 MB of game data, but some of this may be used as file control information.

The memory card (8MB) (for PlayStation®2) uses MAGICGATE, a technology that helps protect copyrighted content through data encryption and hardware authentication.

MAGICGATE is a term of copyright protection technology developed by Sony Group.
MAGICGATE does not guarantee compatibility with other products bearing the “MagicGate” trademark.

② Memory card (sold separately)

The memory card can save and load PlayStation® format software game data. Each memory card can save 120 KB (15 memory blocks) of game data.

Note

You cannot copy data to a memory card (8MB) (for PlayStation®2) or memory card that does not have enough memory available. Before playing, check how much space is needed to save the game and how much space is available on the memory card (8MB) (for PlayStation®2) or memory card. Check the appropriate software manual to determine the amount of space needed to save the data for a given game.

Inserting the memory card (8MB) (for PlayStation®2) or memory card

Insert the memory card (8MB) (for PlayStation®2) or the memory card into the MEMORY CARD slot, with the arrow side up.

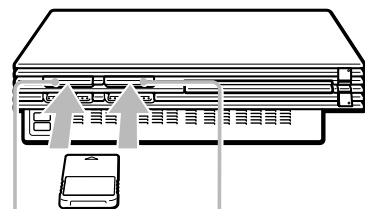

Notes on using the memory card (8MB) (for PlayStation®2) or memory card with a multitap

- When using PlayStation®2 format software, use the SCPH-10090 G multitap (for PlayStation®2).
- When using PlayStation® format software, use the SCPH-1070 G multitap.
- **When you insert the SCPH-1070 G multitap into controller port 1, do not insert the memory card (8MB) (for PlayStation®2) or memory card into memory card slot 1 of the PlayStation®2 console. This also applies when you insert a multitap into controller port 2. If you do so, the data may be lost.**

Checking/copying/deleting game data

You can copy game data from one memory card (8MB) (for PlayStation®2) or memory card to another or delete data you no longer wish to keep.

You cannot, however, copy game data of the PlayStation®2 format software to the memory card.

You can check, copy and delete game data in the Browser screen. For details on the browser, see “Checking/copying/deleting data” on page 8.

Note

You cannot save or load game data in the Browser screen. For details on game data saving or loading, refer to the software manual.

Playing an audio CD

- 1 Press the \triangle (open) button.
The disc tray opens.
- 2 Place a disc on the disc tray with the label side facing up (data side down).
- 3 Press the \triangle button.
The disc tray closes.
- 4 Use the directional buttons to select the audio CD icon, and press the \times button.
The audio CD screen is displayed.
- 5 Select the track number you want to play and press the \times button.
Playback begins.

Ending audio CD playback

- 1 Press the \triangle (open) button.
The disc tray opens.
- 2 Remove the disc.
- 3 Press the \triangle button.
The disc tray closes.
- 4 Press and hold down the \odot (standby)/reset button for more than three seconds.
The console enters standby mode.

Operating the CD player

The CD player can be operated using the Control Panel or directly with the buttons on the analog controller (DUALSHOCK®2). You can also operate the CD player using the SCPH-10420 G DVD remote control (for PlayStation®2), which is sold separately. During playback, select the icon in the CD operation screen using the directional buttons. Then press the X button.

- ▶ Start playback
- ⏸ Pause
- Stop playback
- ⏮ Find the beginning of the current or previous track
- ⏭ Find the beginning of the next track
- ⏪ Fast reverse
- ⏩ Fast forward

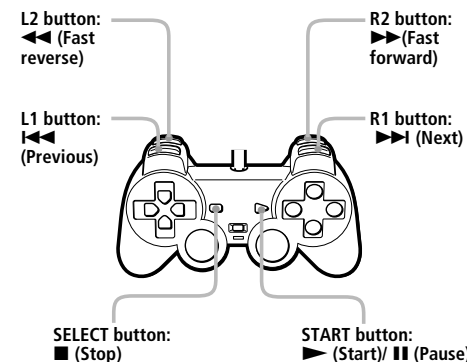

Music discs encoded with copyright protection technologies

The audio CD playback feature of this product is designed to conform to the Compact Disc (CD) standard. Recently, some record companies have started marketing music discs encoded with copyright protection technologies. Some of these music discs do not conform to the CD standard, and may not be playable on this product.

Playing in various modes

You can change between various play modes. The default setting for "Play Mode" is "Normal", and the default for "Repeat" is "Off".

Select the audio CD icon in the Browser screen, and then press the Δ button to change the settings.

To play the desired tracks in a specified order

- 1** Select "Play Mode" using the directional buttons and press the \times button.
- 2** Select "Program" using the directional buttons and press the \times button.
- 3** Select the number of the specific track using the directional buttons, and then press the \times button.
Repeat this step to select all the tracks you want to play.
- 4** Press the \circ button to return to the Browser screen.
- 5** Select the audio CD icon and press the \times button.

The tracks are displayed in their programmed order. Select the track number you want to play, and press the \times button. Playback begins.

To play the desired tracks repeatedly

Follow steps 1 to 4, and then follow the instructions on playing all tracks repeatedly, or on playing one track repeatedly. For details, see "To play all tracks repeatedly" or "To play a track repeatedly" at right.

To play the tracks in random order

- 1** Select "Play Mode" using the directional buttons and press the \times button.
- 2** Select "Shuffle" using the directional buttons and press the \times button.
- 3** Press the \circ button to return to the Browser screen.
- 4** Select the audio CD icon, and press the \times button.
The tracks are displayed in random order. Select the track number you want to play, and press the \times button. Playback begins.

To play random tracks repeatedly

Follow steps 1 to 3, and then follow the instructions on playing all tracks repeatedly, or on playing one track repeatedly. For details, see "To play all tracks repeatedly" or "To play a track repeatedly" below.

To play all tracks repeatedly

- 1** Select "Repeat" using the directional buttons and press the \times button.
- 2** Select "All" using the directional buttons and press the \times button.
- 3** Press the \circ button to return to the Browser screen.
- 4** Select the audio CD icon, and press the \times button.
The tracks are displayed. Select the track number you want to play, and press the \times button. Playback begins.

To play desired or random tracks repeatedly

Follow steps 1 to 3, then follow the instructions on playing the desired tracks in a specified or random order. For details, see "To play the desired tracks in a specified order" or "To play the tracks in random order" at left.

To play a track repeatedly

- 1** Select "Repeat" using the directional buttons and press the \times button.
- 2** Select "1" using the directional buttons and press the \times button.
- 3** Press the \circ button to return to the Browser screen.
- 4** Select the audio CD icon, and press the \times button.
The tracks are displayed. Select the track number you want to play, and press the \times button. Playback begins.

To play a track in Program Play or Shuffle Play repeatedly

Follow steps 1 to 3, then follow the instructions on playing desired tracks or tracks in random order. For details, see "To play the desired tracks in a specified order" or "To play the tracks in random order" at left.

You can go to the Play Options screen from the screen displaying the track numbers.

Select the small audio CD icon on the top left of the screen using the up or left directional button, and press the Δ button. The Play Options screen is displayed, and you can operate the CD player in the same manner as in "Playing in various modes" at left. Press the \circ button in the Play Options screen and the tracks are displayed. Choose the track you want to play, and press the \times button. Playback begins.

Notes on playing an audio CD with a DTS audio track

- If you play an audio CD recorded in DTS format, an extremely loud noise will be emitted from the analog audio output of an audio device connected to the AV MULTI OUT connector. Be careful not to cause damage to your audio system when the audio device's analog audio output is connected to the receiver (amplifier). You must connect a DTS decoder to the DIGITAL OUT (OPTICAL) connector to playback DTS audio tracks.
- When DIGITAL OUT (OPTICAL) is set to "Off" in the System Configuration menu, you will not be able to hear the DTS audio from an audio CD even if the audio device is connected using an optical digital cable.



Playing a DVD video

Depending on the DVD video, some operations may be different or restricted. Refer to the instructions supplied with your disc.

1 Turn on the console using the main power switch on the console rear.

The (standby) indicator on the console front lights up in red to indicate that the console is now in standby mode.

2 Press the (standby) /reset button.

The indicator turns green and the start-up screen is displayed.

3 Press the (open) button.

The disc tray opens.

4 Place a disc on the disc tray with the label side facing up (data side down).

5 Press the (open) button.

The disc tray closes and DVD content is displayed on the screen.

Notes

- The PlayStation®2 console is equipped with advanced playback features that can optimize audio/video quality. For details on adjusting settings to enable these advanced features, see pages 20-25.
- If you press the button during or after playback, the Browser screen appears.
- When playing a DVD video, do not connect the console to a VCR. If you do, picture quality may be reduced. Connect the console directly to the TV.

Ending DVD video playback

When you have finished viewing a DVD, follow the steps below to save DVD player settings, return to the Browser screen or put the console in standby mode.

1 Press the (open) button.

The disc tray opens and the Browser screen is displayed.

2 Remove the disc.

3 Press the button to close the disc tray.

4 Press and hold down the /reset button for more than three seconds.

The indicator turns red and the console enters standby mode.

Note

To save changes to DVD player settings you must eject the DVD before pressing the (standby)/reset button or turning off the console using the main power switch on the console rear.

If you experience problems playing a DVD video:

In rare instances, certain DVD videos may not operate properly with PlayStation®2. This is primarily due to variations in the manufacturing process or software encoding of the DVD video software. If you experience problems, try restarting your DVD video. If problems persist, for more information call the PlayStation® service line number listed on your warranty card for technical assistance.

Operating the DVD player

There are three ways to operate the DVD player:

- You can operate the DVD player directly using the analog controller (DUALSHOCK®2) as explained below.
- You can operate the DVD player through the on-screen Control Panel. The Control Panel allows access to additional DVD player options and settings. For details, see “Using the Control Panel” on page 15.

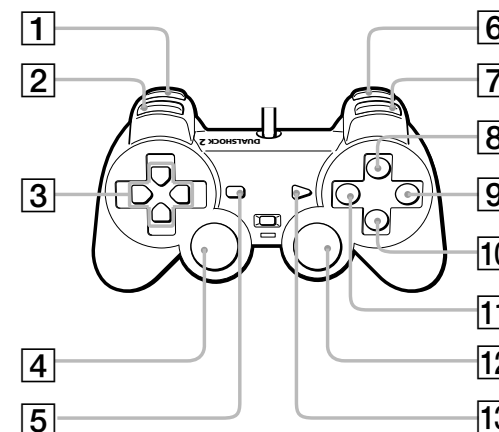

1 L2 button (Fast Reverse Search)

Fast reverses playback on the screen to aid in looking for a particular scene.

2 L1 button (Previous)

Returns to the beginning of the current or previous chapter.

3 Up, down, right, and left directional buttons

Used to select items displayed on the screen.

4 L3 button (Subtitle Options)*

Displays and changes DVD subtitle options.

5 SELECT button

Displays the Control Panel.

6 R2 button (Fast Forward Search)

Fast forwards playback on the screen to aid in looking for a particular scene.

7 R1 button (Next)

Skips to the beginning of the next chapter.

- You can also operate the DVD player using the DVD remote control (for PlayStation®2), which is sold separately.

Using the analog controller (DUALSHOCK®2)

The function of each button on the analog controller (DUALSHOCK®2) is explained below.

Note

The direct button functions of the analog controller (DUALSHOCK®2) cannot be used when the Control Panel is displayed.

8 button (Menu)

Displays the disc menu of DVD-Video discs. The content of the menu varies from disc to disc.

9 button (Stop)

Stops playback.

10 button (Enter)

Enters the item selected on the screen.

11 button (Top Menu)

Displays the disc menu of DVD-Video discs. The content of the menu varies from disc to disc.

12 button (Audio Options)*

Displays and changes DVD audio options.

13 button (Play/II Pause)

Starts playback/Pauses and resumes playback.

- * When using a controller without the L3 or R3 buttons, use the Control Panel to select among available subtitle and audio options.

Using the Control Panel

You can select various playback modes and adjust DVD player settings using the on-screen Control Panel.

Navigate the Control Panel using the analog controller (DUALSHOCK®2) as described below.

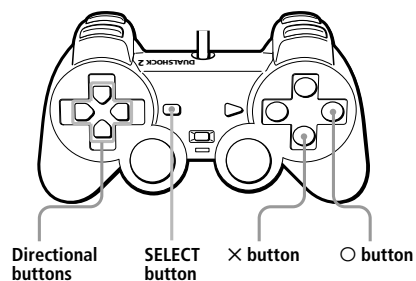

Display or turn off the Control Panel	SELECT button
Enter	X button
Cancel	O button
Select	Up, down, left, and right directional buttons

1 Press the SELECT button.

The Control Panel is displayed.

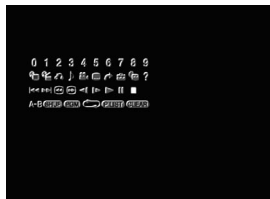

2 Select the item you want using the directional buttons.

3 Press the X button.

For details on each Control Panel display item, see pages 16-25.

Control Panel item list





- 1 **Menu (page 16)**
Displays the disc menu of DVD-Video discs. The content of the menu varies from disc to disc.
- 2 **Top Menu (page 16)**
Displays the disc menu of DVD-Video discs. The content of the menu varies from disc to disc.
- 3 **Return (page 16)**
Returns to the previously selected screen.
- 4 **Audio Options (page 19)**
Displays and changes DVD audio options.
- 5 **Angle Options (page 19)**
Displays and changes DVD viewing angles.
- 6 **Subtitle Options (page 19)**
Displays and changes DVD subtitle options.
- 7 **Go To (page 19)**
Skips to the selected title or chapter number or the specified time, and starts playback.
- 8 **Setup (page 20)**
Displays the Setup display for changing various picture and audio options. You can also choose a language for subtitles and the menu, set Parental Control level, and so on.
- 9 **Time Display (page 16)**
Displays the current title or chapter number, and the elapsed or remaining time.
- 10 **? Help (page 19)**
Displays the direct button functions of the analog controller (DUALSHOCK®2).
- 11 **Go to Chapter (page 19) /Number icons**
Used to enter the number of a chapter you wish to play, or numerical codes.
- 12 **◀◀ Previous**
Returns to the beginning of the current or previous chapter.
- 13 **▶▶ Next**
Skips to the beginning of the next chapter.
- 14 **↔ Search (page 20)**
Fast reverses playback on the screen to aid in looking for a particular scene.
- 15 **⏭ Search (page 20)**
Fast forwards playback on the screen to aid in looking for a particular scene.
- 16 **◀ Slow (page 20)**
Changes to reverse playback in slow-motion.
- 17 **▶ Slow (page 20)**
Changes to playback in slow-motion.
- 18 **▶ Play**
Starts playback.
- 19 **⏸ Pause**
Pauses and resumes playback.
- 20 **■ Stop**
Stops playback.
- 21 **A-B A-B Repeat (page 18)**
Specifies a scene for playback, and starts playback of the scene that has been set.
- 22 **SHUFF Shuffle Play (page 17)**
Starts playback of titles or chapters in random order.
- 23 **PGM Program Play (page 16)**
Displays the Program setup screen.
- 24 **↺ Repeat Play (page 17)**
Selects repeated playback of all the titles on the disc, or one title or chapter.
- 25 **PLIST Original/Play List (page 18)**
For DVD-RW discs recorded in VR mode. Selects Original or Play List content to playback.
- 26 **CLEAR Clear**
Clears selected numbers or playback modes.

You can use the Control Panel to set various playback modes.

Using the DVD disc menu

Some DVDs allow you to select disc contents from a menu. When you play such DVDs, you can select the language for the subtitles, the language for the sound, and other options using the menu.

- 1 Use the directional buttons to select the  (Menu) or  (Top Menu) icon, and press the X button.

The menu is displayed. Menu content may vary depending on the DVD.

- 2 Use the directional buttons to select an item, and press the X button.

To return to the previous screen in the menu

Use the directional buttons to select the  (Return) icon, and press the X button. This function may not be available on some DVDs.

Using the analog controller (DUALSHOCK®2)

- 1 Press the  or  button.

The menu is displayed. Menu content may vary depending on the DVD.

- 2 Use the directional buttons to select an item, and press the X button.

Notes

- Some DVDs do not have a menu.
- Depending on the DVD, a menu may be referred to as "DVD Menu", "Title Menu" or "Titles" in the instructions supplied with the disc.

To check playback settings

When playing a disc use the directional buttons to select the  (Time Display) icon, and press the X button. Icons for currently set playback modes will be displayed in the top right corner of the screen.

To clear all playback settings and return to normal playback

Use the directional buttons to select the  icon, and press the X button.

Playback from the last stopping point (Resume Play)

The DVD player remembers the point where you stopped the disc, and resumes playback from that point.

- 1 During playback, press the  button to stop playback.

The message, "Press [Play] to resume viewing. To start from the beginning, press [Stop] and then [Play]." appears, and then the Control Panel (page 15) is displayed.

If the message "Resume function cannot be used here. Play will restart from the beginning." appears, Resume Play is not available.

- 2 Select the  (Play) icon using the directional buttons and press the X button.

The DVD player starts playback from the point where you stopped the disc in step 1.



To clear the last stopping point

After step 1, select the  (Stop) icon and press the X button.

To clear Resume Play

If you resume playback after stopping, the DVD player enters Resume Play mode. Many advanced settings for the DVD player are not available during Resume Play. If you want to clear Resume Play to adjust settings, select the  (Stop) icon and press the X button twice.

Notes

- Resume Play may not be available on some DVDs or for some video scenes.
- Depending on where you stop playback, the console may resume playback from a slightly different point.
- Resume Play is not available when:
 - Program Play or Shuffle Play is selected.
 - The disc tray on the console front is opened using the  button.
 - The console is reset or goes into standby mode after the /reset button has been pressed.
 - The power is turned off using the main power switch on the console rear.
 - The  (Stop) icon is selected and the X button is pressed twice during playback.

Playback in desired order (Program Play)

You can create a program to play back titles and chapters in any order you like.

- 1 Use the directional buttons to select the  (Program Play) icon, and press the X button.
- 2 Use the directional buttons to select the item number, and press the X button.
- 3 Use the directional buttons to select the title number, and press the X button.
- 4 Use the directional buttons to select the chapter number, and press the X button.
- 5 Repeat steps 2 - 4 to set other titles or chapters.

6 Press the START button.

Program Play begins.

Program Play settings are saved and remain in effect even after playback ends. Use the directional buttons to select the  (Program Play) icon, and then press the X button. The Program Setup screen is displayed. Press the START button to play the programmed sequence again.

Changing or clearing Program Play settings

- 1 Use the directional buttons to select the  (Program Play) icon, and press the X button.
- 2 Use the directional buttons to select the item number you want to change, and press the X button.
- 3 Use the directional buttons to select the title number you want to play, and press the X button.
- 4 Use the directional buttons to select the chapter number you want to play, and press the X button.

To clear Program Play settings, select "Clear" at step 3, and press the X button.

To clear all Program Play settings



- 1 Use the directional buttons to select the  (Program Play) icon, and press the X button.
- 2 Use the directional buttons to select "Clear all", and press the X button.

To use Program Play with Shuffle Play or Repeat Play

- Program Play with Shuffle Play
During playback in Program Play mode, use the directional buttons to select the **SHUF** (Shuffle Play) icon, and press the X button. Shuffle Play is turned on.
When Shuffle Play is used with Program Play, Shuffle Play options are limited to "Shuffle On" and "Shuffle Off".
- Program Play with Repeat Play
During playback in Program Play mode, use the directional buttons to select the  (Repeat) icon, and press the X button. Repeat Play is turned on.
When Repeat Play is used with Program Play, Repeat Play options are limited to "Repeat On" and "Repeat Off".

For details on Shuffle Play and Repeat Play, see "Playback in random order (Shuffle Play)", and "Repeated Playback (Repeat Play)" at right.

Notes

- Program Play settings cannot be changed while playing in Program Play mode.
- A-B Repeat is cleared when Program Play is set.
- Program Play may not be available for some discs.
- Only the number of titles and chapters recorded in the disc will be displayed on the screen.
- Program Play is stopped when:
 - A-B Repeat is set.
 - The DVD disc menu is displayed.
- Program Play settings are cleared when:
 - The disc tray is opened using the  button on the console front.
 - The console is reset or goes into standby mode after the /reset button has been pressed.
 - The power is turned off using the main power switch on the console rear.

Playback in random order (Shuffle Play)

The console will automatically select a random order to play titles and chapters. Playback order will be different each time Shuffle Play is used.

During playback, use the directional buttons to select the **SHUF** (Shuffle Play) icon, and press the X button.

The screen will display the following shuffle modes in turn each time the X button is pressed. Shuffle Play will begin as soon as the playback mode is selected.

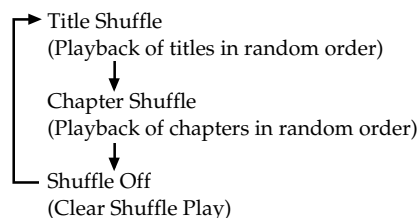

To end Shuffle Play

Use the directional buttons to select the **SHUF** (Shuffle Play) icon, and press the X button until "Shuffle Off" is displayed.

To use Shuffle Play with Program Play or Repeat Play



- Shuffle Play with Program Play
When playing in Shuffle Play mode, use the directional buttons to select the **PCM** (Program Play) icon, and press the X button to select program settings. Press the START button. Shuffle Play is turned on.
When Program Play is used with Shuffle Play, Shuffle Play options are limited to "Shuffle On" and "Shuffle Off".
- Shuffle Play with Repeat Play
When playing in Shuffle Play mode, use the directional buttons to select the  (Repeat) icon, and press the X button. Repeat Play is turned on.
When Repeat Play is used with Shuffle Play, Repeat Play options are limited to "Repeat On" and "Repeat Off".

For details on Program Play and Repeat Play, see "Playback in desired order (Program Play)" on page 16, or "Repeated playback (Repeat Play)" at right.

To set Shuffle Play when a disc is not playing

Use the directional buttons to select the **SHUF** (Shuffle Play) icon, and press the X button until the shuffle mode you want to set is displayed. Use the directional buttons to select the  (Play) icon, and press the X button. Shuffle Play begins.

Notes

- A-B Repeat is cleared when Shuffle Play is set.
- Shuffle Play may not be available on some discs.
- Shuffle Play is cleared when:
 - A-B Repeat is set.
 - The DVD disc menu is displayed.
 - The disc tray is opened using the  button on the console front.
 - The console is reset or goes into standby mode after the /reset button has been pressed.
 - The power is turned off using the main power switch on the console rear.
- When Chapter Shuffle is selected, up to 200 chapters can be played in random order. If the disc has more than 200 chapters, 200 chapters will be selected at random.

Repeated playback (Repeat Play)

All of the titles on the DVD, or one title or chapter can be repeatedly played back using Repeat Play.

During playback, press the directional buttons to select the  (Repeat) icon, and press the X button.

The screen will display the following repeat modes in turn each time the X button is pressed. Repeat Play will begin as soon as the repeat playback mode is selected.

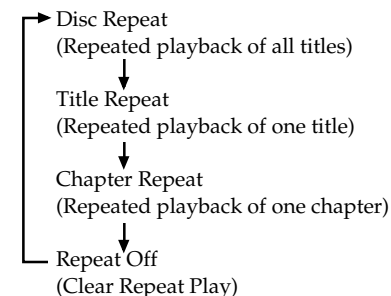

To end Repeat Play



Use the directional buttons to select the  (Repeat) icon, and press the X button until "Repeat Off" is displayed.

To use Repeat Play with Program Play or Shuffle Play



- Repeat Play with Program Play
During playback in Repeat Play mode, use the directional buttons to select the **PCM** (Program Play) icon, and press the X button. Make program selections and press the START button. Repeat Play is turned on.
When Program Play is used with Repeat Play, Repeat Play options are limited to "Repeat On" and "Repeat Off".
- Repeat Play with Shuffle Play
During playback in Repeat Play mode, use the directional buttons to select the **SHUF** (Shuffle Play) icon, and press the X button. Repeat Play is turned on.
When Shuffle Play is used with Repeat Play, Repeat Play options are limited to "Repeat On" and "Repeat Off".

For details on Program Play and Shuffle Play, see "Playback in desired order (Program Play)" on page 16, or "Playback in random order (Shuffle Play)" on page 17.

To set Repeat Play when a disc is not playing

Use the directional buttons to select the  (Repeat) icon, and press the X button until the Repeat mode you want is displayed. Use the directional buttons to select the  (Play) icon, and press the X button. Repeat Play begins.

Notes

- A-B Repeat is cleared when Repeat Play is set.
- Repeat Play may not be available on some discs.
- Repeat Play is cleared when:
 - A-B Repeat is set.
 - The disc tray is opened using the  button on the console front.
 - The console is reset or goes into standby mode after the /reset button has been pressed.
 - The power is turned off using the main power switch on the console rear.

Repeated playback of a selected scene (A-B Repeat)

You can set a specific section of the disc to be repeatedly played back.



- 1** During playback, use the directional buttons to select the A-B (A-B Repeat) icon, and press the **X** button at the point you want to start repeated playback.

The starting point (point A) is set.

- 2** Use the directional buttons to select the A-B (A-B Repeat) icon, and press the **X** button at the point you want to end repeated playback.

The ending point (point B) is set, and repeated playback of the section from A to B begins.

Notes

- A-B Repeat Play may not be available on some discs or some sections of a disc.
- The A-B Repeat function can be set for only one section at a time.
- A-B Repeat cannot be set to select a section of video from more than one title.
- A-B Repeat is cleared when:
 - Program Play, Shuffle Play, or Repeat Play has been set
 - Playback has been stopped.
 - The DVD disc menu is displayed.
 - The disc tray is opened using the  button on the console front.
 - The console is reset or goes into standby mode after the /reset button has been pressed.
 - The power is turned off using the main power switch on the console rear.

- When A-B Repeat is set, Program Play, Shuffle Play, and Repeat Play are cleared.

Selecting Original/Play List for DVD-RW playback

DVD-RW discs (VR mode) can play back both original content recorded using a DVD recorder, and Play List content created by editing original content. When using this kind of disc you can select the type of title you want to play.



This setting is not available during Resume Play.

Stop playback, and use the directional buttons to select the  (Original/Play List) icon. Then press the **X** button.

Original and Play List will be selected in turn each time you press the **X** button.

- Original: Playback of originally recorded content.
- Play List: Playback of edited content.

Notes

- The default setting for this option is Play List.
- Note that you cannot record or edit content using this console.
- If a disc has no Play List, the original content will be played back. Play List cannot be selected.
- A-B Repeat cannot be set to select a section of video from more than one title.
- Slow-motion play (in reverse) is not available for DVD-RW discs (VR mode).
- The “Original” setting is cleared when:
 - The disc tray is opened using the  button on the console front.
 - The console is reset or goes into standby mode after the /reset button has been pressed.
 - The power is turned off using the main power switch on the console rear.
- Content recorded on DVD-RW discs in VR mode must be finalized to be viewed on the PlayStation®2 console.

You can use the Control Panel to navigate the DVD and adjust DVD player settings. Note that not all functions are available on all DVD discs.

Changing the audio language

Some DVDs are recorded with audio tracks for multiple languages (multilingual tracks). When you play such DVDs you can select the language you want to hear during playback. The languages you can select may vary depending on the DVD.

Use the directional buttons to select the  (Audio Options) icon, and press the X button. The language changes each time you press the X button.

Using the analog controller (DUALSHOCK®2)

Press the R3 button. The language changes each time you press the R3 button.

Notes

- Due to the programming on some DVDs, you may not be able to change languages even if multilingual tracks are recorded on the DVD.
- When playing a DVD, the audio settings may change when you change titles.
- When you set the “DTS” option of “Audio Digital Out” to “Off” under “Audio Setup” in the Setup display, the sound recording system will not be set to DTS even when playing a DVD with DTS sound recorded.

Changing the viewing angle

With DVDs on which multiple angles (multi-angles) are recorded, you can change the viewing angle on scenes for which multiple angles are available. For example, while playing the scene of a train in motion, you can change the view from the front of the train, the left window, or the right window, without interrupting the movement of the train.

Use the directional buttons to select the  (Angle Options) icon, and press the X button. The angle changes each time you press the X button.

Notes

- The number of angles varies depending on the disc and the scene. For any given scene you can choose from among the angles recorded for that scene.
- Due to the programming on some DVDs, you may not be able to change angles even if multiple angles are recorded on the DVD.

Displaying subtitles

If subtitles are recorded on a DVD, you can turn the subtitles on and off during playback. When multilingual subtitles are available, you can also change the subtitle language.

Use the directional buttons to select the  (Subtitle Options) icon, and press the X button. The subtitle language changes each time you press the X button. The subtitle languages you can select will vary depending on the DVD.

To turn the subtitles off

Use the directional buttons to select the  icon, and press the X button until “Subtitles Off” is displayed.

Using the analog controller (DUALSHOCK®2)

Press the L3 button. The subtitle language changes each time you press the L3 button. The subtitle languages you can select will vary depending on the DVD.

To turn the subtitle language off

Press the L3 button until “Subtitles Off” is displayed.

Notes

- When playing a DVD on which no subtitles are recorded, no subtitles can be displayed.
- Due to the programming on some DVDs, you may not be able to display subtitles or switch among subtitle languages even if subtitles are recorded on the DVD.
- Depending on the DVD, you may not be able to turn the subtitles off.
- The type and number of languages for subtitles varies from disc to disc.
- While playing a DVD, the subtitle setting may change when you change titles.

Selecting a specific scene for playback

You can select a specific scene for playback by specifying the title or chapter number, or by entering the elapsed time for the starting point of the scene that you want to play.

Selecting a scene by chapter number

During playback, use the directional buttons to select the desired chapter number, and press the X button. Playback of the selected chapter begins.

Selecting a scene by title number, chapter number, or by specifying the time.

- 1 During playback, use the directional buttons to select the  (Go To) icon, and press the X button.
- 2 Use the directional buttons to select an item, and press the X button.

- Title = Title number
- Chapter = Chapter number
- C XX:XX:XX (or T XX:XX:XX) = Elapsed time for the chapter (or title)

- 3 Use the directional buttons to select the playback point, and press the X button.

Playback of the selected scene begins.

Note

You cannot select a scene by specifying the remaining time of the chapter or title (only elapsed time can be used).

Displaying playback information

You can display information such as the current title or chapter number, or the elapsed or remaining time on a disc. When Program Play or Shuffle Play modes are set, this information will also be displayed in the top right corner of the screen.

During playback or when the disc is paused, use the directional buttons to select the  (Time Display) icon, and press the X button. The display changes as shown below, each time you press the X button.

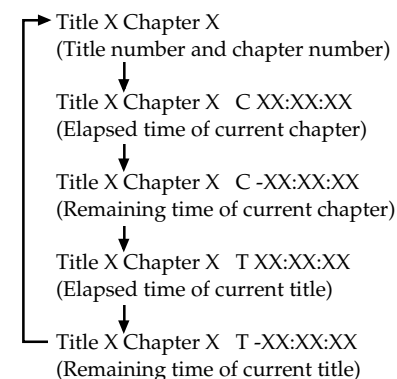

Note

You cannot display the remaining time for some titles.



Displaying the list of direct button functions (Help)

You can display a list that shows the function of each button on the analog controller (DUALSHOCK®2).

Use the directional buttons to select the  (Help) icon, and press the X button. The list of button functions is displayed. The display is turned on and off each time you press the X button.

Finding a particular point on a disc (Search)

You can use the Search function to quickly locate a particular point on a DVD. You can search either forward or backward and can switch between 3 speeds and slow-motion playback speed. This function is also available using the analog controller (DUALSHOCK®2) when the Control Panel is not displayed.

- 1 During playback, use the directional buttons to select the  (Search, Fast Reverse) or  (Search, Fast Forward) icon. Then press and hold down the X button to begin searching. Press the directional buttons to change speeds while searching.

Search speed changes as shown below when you press the directional buttons while holding down the X button.

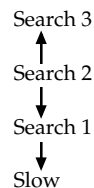

- 2 Release the X button when you reach the point you are searching for.

Playback returns to normal speed.

Using the analog controller (DUALSHOCK®2)

- 1 During playback, press and hold down the L2 or R2 button to begin searching. Press the directional buttons to change speeds while searching.

Search speed changes as shown below when you press the directional buttons while holding down the L2 or R2 button.

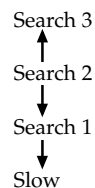



- 2 Release the L2 or R2 button when you reach the point you are searching for.

Playback returns to normal speed.

Note

This function may not be available on some DVDs.

Playing in slow-motion

During playback, use the directional buttons to select the  (Slow Backward) or  (Slow Forward) icon, and press the X button. Slow-motion playback begins.

To end slow-motion playback

Use the directional buttons to select the  (Play) icon, and press the X button. Playback returns to normal speed.

Using the Setup display

You can change the initial settings, adjust the picture and sound, and set various other output options using the Setup display. You can also select a language for subtitles and menus, restrict playback by children, and so on. For details on the Setup display, see pages 21-25.

Before using the Setup display

Some menu items cannot be selected during Resume Play as noted on the pages that follow. For details on clearing Resume Play see "To clear Resume Play" on page 16.

- 1 Use the directional buttons to select the  (Setup) icon, and press the X button.

The Setup icon bar is displayed, giving you the access to the menus shown on page 21.

- 2 Use the directional buttons to select the icon for the setting you would like to change, and press the X button.

The menu for the icon selected is displayed.

- 3 Use the directional buttons to choose a menu item, and press the X button.

The options for the menu item selected are displayed.

- 4 Use the directional buttons to select an option, and press the X button.

The option selected is set.

After using the Setup display

To save changes made during playback, you must stop playback* or eject the DVD before pressing the  (standby)/reset button on the console front or turning off the console using the main power switch on the console rear. Note that changes will not be saved if you reset or turn off the console before stopping playback, or without first ejecting the DVD.

* Stopping playback during Resume Play is included.

Setup display menus

The Setup display menus are organized as shown below. The default settings are underlined.

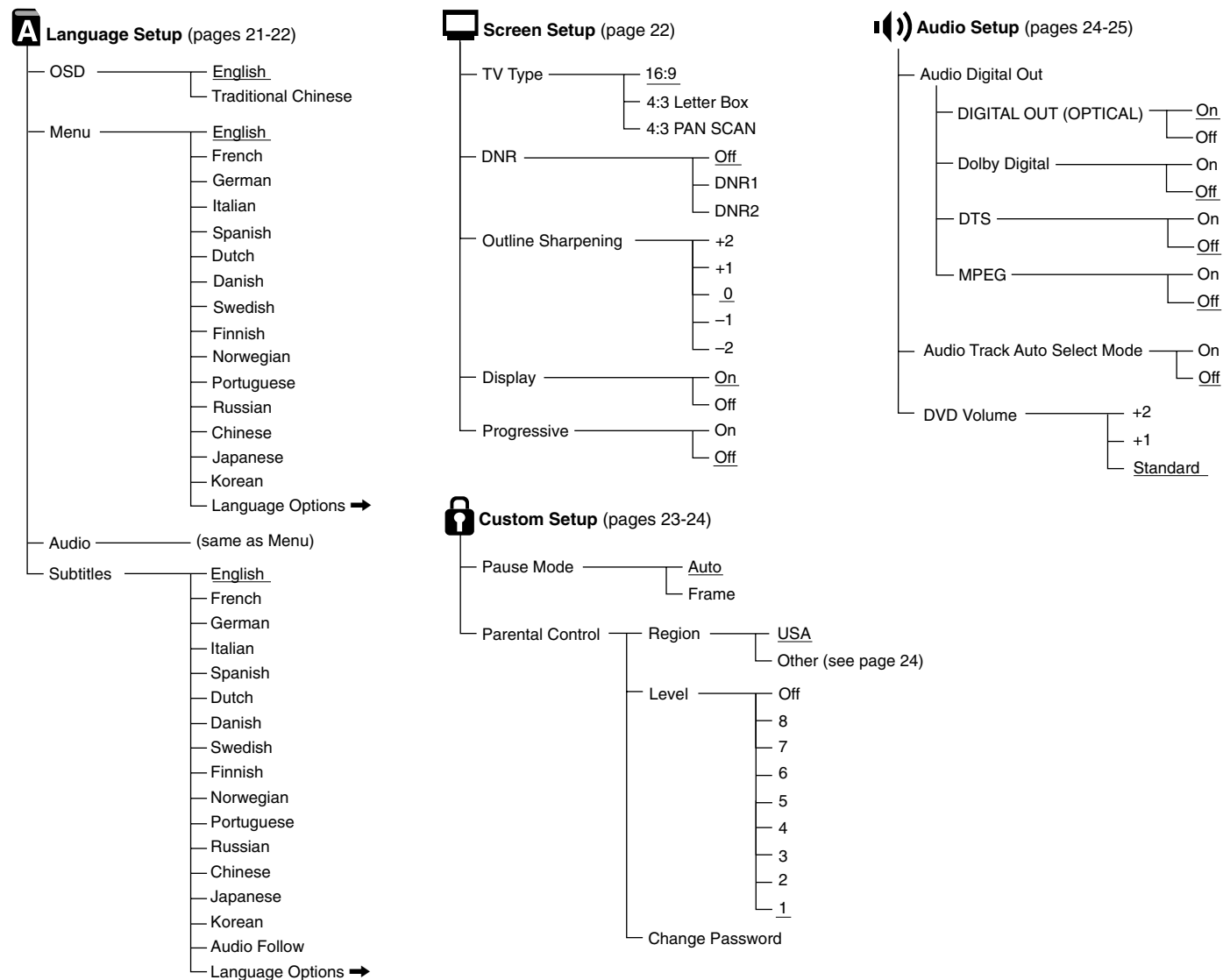

Setting language options (Language Setup)

“Language Setup” allows you to choose from among various languages for the on-screen display (OSD), DVD audio, and other items. The default setting for each menu item is underlined in the explanations below.

Select the **A** (Language Setup) icon in the Setup display. For details, see “Using the Setup display” on page 20.

Notes

- When you select a language that is not recorded on the DVD, one of the recorded languages is automatically selected for the “Menu,” “Audio” and “Subtitles” settings.
- Depending on the DVD, the language you have selected for the “Menu,” “Audio” or “Subtitles” may not be used.

OSD

Selects the language for the on-screen display.

- English
- Traditional Chinese

Menu

Selects the language for the DVD disc menu. This setting is not available during Resume Play.

- English
- French
- German
- Italian
- Spanish
- Dutch
- Danish
- Swedish
- Finnish
- Norwegian
- Portuguese
- Russian
- Chinese
- Japanese
- Korean
- Language Options*

* When you select “Language Options,” you can choose from an extensive list of languages.

■ Audio

Selects the language for the audio track. This setting is not available during Resume Play.

- English
- French
- German
- Italian
- Spanish
- Dutch
- Danish
- Swedish
- Finnish
- Norwegian
- Portuguese
- Russian
- Chinese
- Japanese
- Korean
- Language Options*

* When you select "Language Options," you can choose from an extensive list of languages.

■ Subtitle

Selects the language for the subtitles. This setting is not available during Resume Play.

- English
- French
- German
- Italian
- Spanish
- Dutch
- Danish
- Swedish
- Finnish
- Norwegian
- Portuguese
- Russian
- Chinese
- Japanese
- Korean
- Audio Follow^{*1}
- Language Options^{*2}

*1 When you select "Audio Follow," the language for subtitles automatically changes to match the language you have selected for the audio track.

*2 When you select "Language Options," you can choose from an extensive list of languages.

Setting TV display options (Screen Setup)

You can set the aspect ratio and other display options for the connected TV using this setting. The default setting for each menu is underlined in the explanations below.

Select the  (Screen Setup) icon in the Setup display. For details, see "Using the Setup display" on page 20.

■ TV Type

Sets the aspect ratio of the TV. This setting is not available during Resume Play.

- 16:9: Select this option when using a wide-screen TV, or a standard TV that displays in wide mode.
- 4:3 Letter Box: Select this option when using a standard TV. This setting displays a wide picture with margins on the upper and lower portions of the screen.
- 4:3 PAN SCAN: Select this option when using a standard TV. This setting displays a wide picture adjusted to the height of the screen, cutting off the portions at left and right that do not fit.

16:9

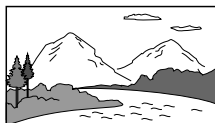

4:3 Letter Box

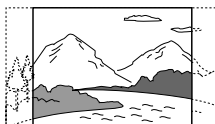

4:3 PAN SCAN

**Notes**

- Some DVDs may automatically set the aspect ratio of the TV.
- When "Progressive" is set to "On", the aspect ratio of the TV is set to 16:9 and cannot be changed.

■ DNR (Digital Noise Reduction)

This setting may help reduce roughness in the on-screen image and produce a cleaner picture.

- Off: Normally select this position.
- DNR1: Increases picture clarity
- DNR2: Increases picture clarity (maximum).

Notes

- DNR2 is more effective for reducing image roughness than DNR1, but in some cases an afterimage may appear. If this occurs, select "Off."
- The DNR function may produce limited results on some DVDs.
- When "Progressive" is set to "On", DNR is automatically turned off and cannot be turned on.

■ Outline Sharpening

You can sharpen or soften the outline of the on-screen image using this setting. The higher the value, the sharper the outline.

- +2
- +1
- 0: Normally select this position.
- -1
- -2

■ Display

You can display or turn off playback status information in the top right corner of the screen.

- On: When playing a DVD, the playback status information is displayed for a few seconds.
- Off: Playback status information is not displayed.

■ Progressive

This method of displaying a picture updates all the lines in one pass, resulting in most cases in a more stable, clearer, flicker-free image than standard interlace mode.

This setting is not available during Resume Play.

- On: Select this when the console is connected to a TV that supports progressive scan (480p).
- Off: Select this when the console is connected to a normal TV.

Notes

- To use progressive scan you must have a TV that supports progressive scan (480p) and you must connect your console using the SCPH-10100 G component AV cable (for PlayStation®2), which is sold separately.
- If you set "Progressive" to "On" without the necessary equipment, picture quality may be reduced, or the picture may not be displayed.
- If you accidentally set this option to "On" and need to clear the setting, with the DVD inserted in the console press the  (standby)/reset button on the console front. Then hold down the START button of the analog controller (DUALSHOCK®2) inserted into controller port 1 until the DVD picture is displayed. When DVD playback begins, "Progressive" will be set to "Off", allowing the DVD video to be displayed as normal. "Progressive" can also be set to "Off" in the Version Information screen. See page 9 for details.
- Progressive scan is not available when playing a DVD-RW disc with content recorded in VR mode.
- DVDs can contain video based material and film based material, which use different frame rates. When playing video based material using progressive scan, some video images may appear unnatural. This is due to an image conversion process. If this occurs, set "Progressive" to "Off" and view in standard interlace mode.

Setting viewer options (Custom Setup)

You can set the Parental Control level and adjust other playback features using Custom Setup.

The default setting for each menu is underlined in the explanations below.

Select the  (Custom Setup) icon in the Setup display. For details see "Using the Setup display" on page 20.

■ Pause Mode

Sets the picture status in pause mode.

- Auto: A picture with a lot of moving elements can be displayed without jitter. Normally select this position.
- Frame: A picture without a lot of moving elements can be displayed in high resolution.

■ Parental Control

The viewing of some DVD content may be restricted based on viewer age or other factors in some regions. You can use the Parental Control feature to restrict the level of content that may be viewed on your console. This setting is not available during Resume Play.

Setting Parental Control

Select the **6** (Custom Setup) icon in the Setup display.

- 1 Use the directional buttons to select "Parental Control", and press the **X** button.

If you have not registered a password

The screen for registering a password is displayed.

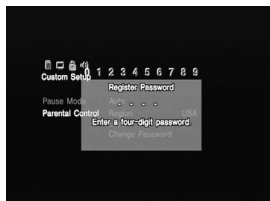

If a password has already been registered

The screen for confirming the password is displayed.

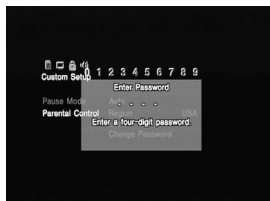

- 2 Use the directional buttons to select a number, and press the **X** button.

Repeat this step to enter a four-digit password. The screen for setting the region, Parental Control level, and for changing your password is displayed.

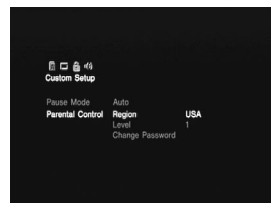

- 3 Use the directional buttons to select "Region", and press the **X** button.



- 4 Use the directional buttons to select the region to base Parental Control levels on, and press the **X** button.

If you select "Other", refer to the "Region code list" at right for the region code to select.

Use the directional buttons to select the first letter, and press the right directional button. Use the directional buttons to select the second letter, and press the **X** button.

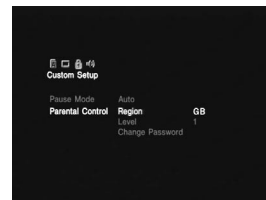

- 5 Use the directional buttons to select "Level", and press the **X** button.

The list of level options is displayed.

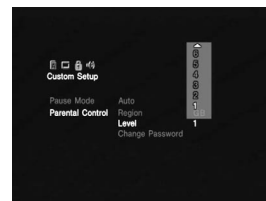

- 6 Use the directional buttons to select a restriction level, and press the **X** button.

Parental Control is set. The lower the value, the stricter the restriction.

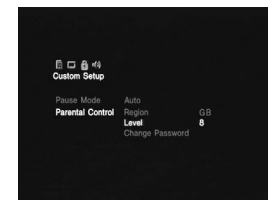

Region code list

Region	Code	Region	Code
United Kingdom	GB	China	CN
Italy	IT	Denmark	DK
Indonesia	ID	Germany	DE
Austria	AT	Japan	JP
Netherlands	NL	Norway	NO
Canada	CA	Philippines	PH
Korea	KR	Finland	FI
Singapore	SG	France	FR
Switzerland	CH	Belgium	BE
Sweden	SE	Hong Kong	HK
Spain	ES	Malaysia	MY
Thailand	TH	Russia	RU
Taiwan	TW		

To change your password

- 1** In step 2 under "Setting Parental Control" use the directional buttons to select "Change Password", and press the **X** button.

The screen for changing the password is displayed.

- 2** Use the directional buttons to select a number, and press the **X** button.

Repeat this step to enter a four-digit password. To confirm your password, enter it once again. The password is changed.

Playing a disc which is restricted by Parental Control

- 1** Insert the disc.

Playback begins automatically, and at the point where Parental Control is set, the screen changes to a display requesting confirmation to temporarily change the Parental Control level.

- 2** Use the directional buttons to select "Yes", and press the **X** button.

The screen for confirming the password is displayed.

- 3** Use the directional buttons to select a number, and press the **X** button. Repeat this procedure to enter the four-digit password.

Playback begins.

When DVD playback is stopped, the Parental Control level returns to the original setting.

If you forget your password

- 1** Press the **SELECT** button when the screen for confirming the password is displayed.

The screen for deleting the password is displayed.

- 2** Use the directional buttons to select a number, and press the **X** button.

Repeat this procedure to enter the four-digit number "7444". The current password is deleted and the screen for registering a new password is displayed.

- 3** Follow step 2 in "Setting Parental Control", to register a new password.

Notes

- If you play a DVD that does not have the Parental Control function, playback will not be restricted even if you set a playback restriction level on your console.
- If you do not set a password, you cannot change the Parental Control settings.
- Some DVDs may require you to enter only the password without changing the Parental Control level.
- Program Play, Shuffle Play, Repeat Play, and A-B Repeat may not be available on some DVDs with the Parental Control feature.

To clear Parental Control

With DVD playback stopped, go to step 6 in "Setting Parental Control" and set "Level" to "Off".

This setting cannot be cleared during Resume Play.

Setting sound options (Audio Setup)

You can adjust your audio settings based on the playback conditions or the equipment in use.

The default setting for each menu is underlined in the explanations below. For details see "Using the Setup display" on page 20.

Select the **(A)** (Audio Setup) icon in the Setup display.

■ Audio Digital Out

You can switch the methods of outputting audio signal when you connect the following audio devices to the DIGITAL OUT (OPTICAL) connector on the PlayStation®2 console rear using an optical digital cable (sold separately).

- A digital device such as a receiver (amplifier) with a digital connector.
- An audio device with a built-in Dolby Digital DTS or MPEG decoder.
- A DAT (Digital Audio Tape) or MD (MiniDisc) deck. For connection details, see page 7.

■ DIGITAL OUT (OPTICAL)

Selects whether to output signal through the DIGITAL OUT (OPTICAL) connector.

- On: Select this when you connect with an optical digital cable (sold separately). Normally select this option. If you select "On", make the appropriate settings for "Dolby Digital" "DTS" and "MPEG".
- Off: Select this when you do not want sound (audio signal) to be output through the DIGITAL OUT (OPTICAL) connector.

Note

If you select "Off", you cannot set "Dolby Digital" "DTS" or "MPEG".

■ Dolby Digital

Selects the Dolby Digital signal to be output through the DIGITAL OUT (OPTICAL) connector.

- On: Select this option when the console is connected to an audio device with a built-in Dolby Digital decoder. If the console is connected to an audio device without a built-in Dolby Digital decoder, do not turn this option on. If you select this option by mistake, when you play a Dolby Digital audio track, a loud noise (or no sound) will come out from the speakers, possibly hurting your ears or damaging the speakers.
- Off: Select this option when the console is connected to an audio device without a built-in Dolby Digital decoder.

■ DTS

Selects the DTS signal to be output through the DIGITAL OUT (OPTICAL) connector when you connect to the console with an optical digital cable (sold separately).

This setting is not available during Resume Play.

- On: Select this option when the console is connected to an audio device with a built-in DTS decoder. If the console is connected to an audio device without a built-in DTS decoder, do not turn this option on. If you select this option by mistake, when you play a DTS audio track, a loud noise (or no sound) will come out from the speakers, possibly hurting your ears or damaging the speakers.
- Off: Select this option when the console is connected to an audio device without a built-in DTS decoder.

■ MPEG

Selects the MPEG AUDIO signals to be output via the DIGITAL OUT (OPTICAL) connector.

- **On** : when the console is connected to audio equipment with a built-in MPEG decoder. If the console is connected to audio equipment without a built-in MPEG decoder, do not turn this option on. Otherwise, when you play the MPEG sound track, a loud noise (or no sound) will come out from the speakers, possibly hurting your ears or damaging the speakers.
- **Off** : when the console is connected to audio equipment without a built-in MPEG decoder.

■ Audio Track Auto Select Mode

Gives the audio track that contains the highest number of channels priority when you play a DVD on which multiple audio formats (PCM, Dolby Digital DTS or MPEG AUDIO format) are recorded.

This setting is not available during Resume Play.

- **On**: Priority given
- **Off**: No priority given

Notes

- If you set this item to “On,” the language may change because the “Audio Track Auto Select Mode” setting has higher priority than the “Audio” settings in “Language Setup” (page 21).
- If you set “DIGITAL OUT (OPTICAL)” to “On” and “DTS” to “Off” in “Audio Setup”, the DTS audio track is not played even if you set this item to “On” and the highest-numbered audio channel is recorded in DTS format.
- If PCM, DTS Dolby Digital and MPEG AUDIO audio tracks have the same number of channels, the console selects PCM, Dolby Digital DTS and MPEG AUDIO audio tracks in this order.
- Depending on the DVD, the audio channel with priority may be predetermined. In this case, you cannot give priority to the DTS Dolby Digital or MPEG AUDIO format by selecting “On”.

■ DVD Volume

If the audio output level of the DVD is low, you can turn up the volume of the DVD. DIGITAL OUT (OPTICAL) must be set to “Off” to change this setting.

- **+2**: Turns up the volume (maximum).
- **+1**: Turns up the volume.
- **Standard**: Original audio volume. Normally select this position.

Note

If you set this option to “+1” or “+2”, the sound may be distorted in places where loud sound is present. If the sound becomes distorted, select “Standard”.

Caution

If you turn up the volume too high, your ears may be injured or the speakers may be damaged.

This product incorporates copyright protection technology that is protected by method claims of certain U.S. patents and other intellectual property rights owned by Macrovision Corporation and other rights owners. Use of this copyright protection technology must be authorized by Macrovision Corporation, and is intended for home and other limited viewing uses only unless otherwise authorized by Macrovision Corporation. Reverse engineering or disassembly is prohibited.



Please go through this section if you experience difficulty in operating the PlayStation®2 console.

- **If you experience any of the following difficulties, use this troubleshooting guide to help remedy the problem before requesting repair. Should any problem persist, call the PlayStation® service line number listed on your warranty card for technical assistance.**
- **Make sure the AC power cord is connected to the console and the wall outlet, and the TV (or VCR) or the supplied accessories are connected to the console correctly.**

Power

The power is not turned on.

- ➔ Check that the AC power cord is connected securely.
- ➔ The console is not turned on. Turn on the console using the main power switch on the console rear.

Picture

There is no picture.

- ➔ Check that the console is connected to the TV (or VCR) with the AV cable (integrated audio/video).
- ➔ Check that the console and the TV (or VCR) are turned on.
- ➔ Check that you have selected the video input on the TV (or VCR).
- ➔ Check that the AV cable (integrated audio/video) is connected securely.
- ➔ Check that the inserted disc can be played with this console (see page 3).
- ➔ Check that the disc is placed with the label side facing up (data side down).
- ➔ The disc is not inserted correctly.

- ➔ DVD playback has been stopped.
- ➔ Try another set of AV cables.
- ➔ The progressive scan option is set to "On" when using a TV that does not support progressive scan (480p), or when using a cable other than the component AV cable (for PlayStation®2).
With the DVD inserted in the console, press the ⏻ (standby)/reset button on the console front. Then hold down the START button of the analog controller (DUALSHOCK®2) inserted into controller port 1 until the DVD picture is displayed. When DVD playback begins, "Progressive" will be set to "Off", allowing the DVD video to be displayed as normal. "Progressive" can also be set to "Off" in the Version Information screen (page 9).

Picture noise appears.

- ➔ The console is placed on an unstable surface. Place the console on a stable and flat surface. Do not shake or vibrate the console.
- ➔ Clean the disc.
- ➔ Moisture has condensed inside the console (see page 2).
- ➔ If the video signal from the console has to go through the VCR to get to the TV, the copy protection applied to some DVD videos could affect picture quality. When playing a DVD video, connect the console to the TV directly (see page 6).
- ➔ The progressive scan option is set to "On" when using a TV that does not support progressive scan (480p), or when using a cable other than the component AV cable (for PlayStation®2).
Do not open the disc tray or remove the DVD. With the DVD inserted in the console, press the ⏻ (standby)/reset button on the console front. Then hold down the START button of the analog controller (DUALSHOCK®2) inserted into controller port 1 until the DVD picture is displayed. When DVD playback begins, "Progressive" will be set to "Off", allowing the DVD video to be displayed as normal. "Progressive" can also be set to "Off" in the Version Information screen (page 9).

- ➔ Some video images appear unnatural when using progressive scan, even when the TV supports progressive mode.
Set "Progressive" to "Off", and view in standard interlace mode.

The aspect ratio cannot be changed according to the TV when playing wide picture DVD videos.

- ➔ Depending on the disc, the aspect ratio is fixed.
- ➔ Check that the console is connected to the TV directly. (The selector or receiver (amplifier) may be connected between the console and the TV.)
- ➔ Depending on the TV, the aspect ratio is fixed.

When playing a DVD-RW disc recorded in VR mode, the message "Playback is restricted. Cannot play." is displayed on the screen and then the screen turns blue.

- ➔ You may be playing a disc that contains "copy-once" content. Video recorded on CPRM-compatible DVD-RW discs using the copy-once feature cannot be played back. For details, see "Notes on the playback of DVD-R/DVD-RW/DVD+R/DVD+RW discs" on page 3.

Sound

There is no sound.

- ➔ Check that the console is connected to the TV (or VCR) with the AV cable (integrated audio/video).
- ➔ Check that the console and the TV (or VCR) are turned on.
- ➔ Check that you have selected the video input on the TV (or VCR).
- ➔ Check that the TV volume is set properly or "mute" is not selected on the TV.
- ➔ Check that the AV cable (integrated audio/video) is connected securely.
- ➔ Check that the inserted disc can be played with this console. (see page 3)
- ➔ Check that the disc is placed with the label side facing up (data side down).

- ➔ Check that you have connected the console to the audio input connectors on the receiver (amplifier) correctly. Refer also to the instructions supplied with your amplifier.
- ➔ Try another set of AV cables.
- ➔ Check the speaker connections and settings. Refer also to the instructions supplied with your amplifier.
- ➔ Check that you have selected the appropriate input on the receiver (amplifier) so that you can listen to sound from the console. Refer also to the instructions supplied with your amplifier.
- ➔ The console is in pause mode.
- ➔ The console is in search/slow-motion mode (when playing a DVD video).
- ➔ You are playing an audio CD or DVD with a DTS audio track.
Do not play back DTS audio tracks when the console is connected to an audio device without a built-in DTS decoder (see page 24).
- ➔ The system setting is not correct for when the console is connected to audio equipment with DIGITAL OUT (OPTICAL) connectors (see page 7).

Poor sound quality.

- ➔ The console is placed on an unstable surface. Place the console on a stable and flat surface. Do not shake or vibrate the console.
- ➔ Clean the disc.
- ➔ Moisture has condensed on the disc (see page 2).
- ➔ You are playing an audio CD or a DVD with DTS audio tracks.
You can play an audio CD or DVD with DTS audio tracks only when the console is connected to audio equipment with a built-in DTS decoder.

The surround effect is difficult to hear when you are playing a DVD video with a Dolby Digital audio track.

- ➔ Check the speaker connections and settings. Refer to the operating manual of your receiver (amplifier).

- ➔ Depending on the DVD, the output signal may not comprise the entire 5.1 channel range. It may be monaural or stereo even if the audio track is recorded in Dolby Digital.

The sound comes from the center speaker only.

- ➔ Depending on the disc, the sound may come from the center speaker only.

Operation

The controller does not function.

- ➔ Check that the controller is connected to the console.
- ➔ Check that the analog controller (DUALSHOCK®2) is set to the appropriate mode for the software (see page 11).
- ➔ Try another set of controllers.
- ➔ Try setting the "Remote Control" setting of the System Configuration menu to "Gameplay Function Off".

Some unlicensed 3rd party peripherals may not operate with "Gameplay Function" set to "On". Note that use of such peripherals is not recommended and will void your warranty.

The software title does not start.

- ➔ Check that the inserted disc can be played with this console (see page 3).
- ➔ Check that the disc is placed with the label side facing up (data side down).
- ➔ Check that the disc is inserted correctly.
- ➔ Clean the disc.
- ➔ Moisture has condensed on the disc (see page 2).
- ➔ Try another copy of the disc.
- ➔ Check that the DVD-R or DVD-RW you are playing has been finalized.

You cannot save data on the memory card (8MB) (for PlayStation®2) or memory card.

- ➔ Check that the memory card (8MB) (for PlayStation®2) or memory card is inserted securely.
- ➔ Check that you are playing the game correctly. Refer to the appropriate software manual.

- ➔ Check that there are empty blocks/free space on the memory card (8MB) (for PlayStation®2) or memory card.
- ➔ Try another memory card (8MB) (for PlayStation®2) or memory card.

The console does not function properly.

- ➔ Static electricity, etc. may affect the console's operation. Turn off the main power switch and then turn it back on.

⏻ indicator flashes in red and the console does not work.

- ➔ A flashing red light indicates a console "fault" condition and the unit will not operate. Remove any obstructions from the vents to allow the console to cool down. Resume play after the console returns to standby mode.

The disc tray does not open.

- ➔ Check that the AC power cord is connected securely.
- ➔ Check that the console is turned on. Turn on the console using the main power switch on the back of the console.

DVD video operation

The console does not play from the beginning when playing a disc.

- ➔ Resume Play has been selected. Select the ■ (Stop) icon and press the × button twice before you start playing (see page 16).
- ➔ Depending on the disc, the DVD disc menu is automatically displayed.

The disc does not play even if the DVD title is selected.

- ➔ A Parental Control level has been set on the disc (see page 23).

Playback stops automatically.

- ➔ The disc may contain an auto pause signal. While playing such a disc, the console stops playback at the signal.

You cannot perform some functions such as Stop, Search, Slow-motion Play, Program Play, Shuffle Play or Repeat Play.

- ➔ Depending on the disc, you may not be able to do some of the operations above.

The language for the audio track cannot be changed.

- ➔ Multilingual tracks are not recorded on the DVD.
- ➔ Changing the language for the track is prohibited on the DVD.

The subtitle language cannot be changed.

- ➔ Multilingual subtitles are not recorded on the DVD.
- ➔ Changing the language for the subtitles is prohibited on the DVD.

The subtitles cannot be turned off.

- ➔ Depending on the DVD, you may not be able to turn the subtitles off.

The angles cannot be changed when you play a DVD.

- ➔ Multi-angles are not recorded on the DVD.
- ➔ Changing the angles is prohibited on the DVD.

The **PLIST** icon cannot be selected.

- ➔ Insert a DVD-RW (VR mode) disc in the console (see page 18).

General

Power requirements	220-240 V AC, 50 Hz
Power consumption	50 W
Console dimensions (approx.)	301 × 78 × 182 mm (w/h/d)
Console weight (approx.)	2.0 kg
Operating temperature	5°C - 35°C
Laser diode properties	<ul style="list-style-type: none"> • Material: GaAlAs • Wavelength: λ=650/780 nm

Inputs/outputs on the console front

Controller port (2)
Memory card slot (2)
ψ USB connector (2)

Inputs/outputs on the console rear

AV MULTI OUT connector (1)
DIGITAL OUT (OPTICAL) connector (1)
Expansion bay (1)

Supplied accessories

See page 4.

Optional accessories

SCPH-10010 G	Analog Controller (DUALSHOCK®2)
SCPH-10020 G	Memory Card (8MB) (for PlayStation®2)
SCPH-10040 G	Vertical Stand (for PlayStation®2)
SCPH-10060 G	S VIDEO Cable
SCPH-10090 G	Multitap (for PlayStation®2)
SCPH-10100 G	Component AV Cable (for PlayStation®2)
SCPH-10110 G	Horizontal Stand (for PlayStation®2)
SCPH-10420 G	DVD Remote Control (for PlayStation®2)
SCPH-1020 HI	Memory Card
SCPH-110	Analog Controller (DUALSHOCK®)

Design and specifications are subject to change without notice.

Chapter (page 19)

Sections of a movie or a music piece on a DVD that are smaller than titles. A title is composed of several chapters. Each chapter is assigned a chapter number enabling you to locate the chapter you want.

Dolby Digital (page 7, 24)

Digital audio compression technology developed by Dolby Laboratories. This technology conforms to 5.1-channel surround sound. The rear channel is stereo and there is a discrete subwoofer channel in this format. Dolby Digital provides the same 5.1 discrete channels of high quality digital audio found in Dolby Digital cinema audio systems. Good channel separation is realized because all of the channel data is recorded discretely and processed in digital.

DTS (page 7, 24)

Digital audio compression technology that Digital Theater Systems, Inc. developed. This technology conforms to 5.1-channel surround sound. The rear channel is stereo and there is a discrete subwoofer channel in this format. DTS provides the same 5.1 discrete channels of high quality digital audio. Good channel separation is realized because all of the channel data is recorded discretely and processed in digital.

DVD-VIDEO (page 3, 15)

DVD VIDEO discs can contain up to 8 hours of moving pictures on a disc with the same diameter as a CD. The picture data uses the MPEG 2 format, one of the worldwide standards of digital compression technology. Audio data is recorded in a multi-channel format allowing you to enjoy a more real audio presence. DVD VIDEO discs also can contain advanced functions such as multiple viewing angles, multilingual tracks and Parental Control playback restrictions.

DVD-RW

DVD-RW is a recordable and rewritable disc that is the same size as a DVD VIDEO disc. DVD-RW discs have two modes: VR mode and Video mode.

- Video mode - complies with DVD-VIDEO format and is compatible with most DVD players once finalized, whereas a DVD-RW recorded in VR mode can only be played on DVD-RW compliant DVD players.

- VR (Video Recording) mode - enables various programming and editing functions, some of which are not available in Video mode.

DVD+RW

DVD+RW (read "plus RW") is a recordable and rewritable disc. DVD+RW discs use a recording format that is comparable to the DVD VIDEO format.

DVD material

DVD material can be divided into two types: video based material and film based material. Video based material is recorded at 30 frames (60 fields) per second, and is normally used for TV programs. Film based material is recorded at 24 video images per second, and is used for most movies. Some DVDs contain both video based and film based material.

MPEG AUDIO (page 25)

International standard coding system to compress audio digital signals authorised by ISO/IEC.

Parental Control (page 23)

A function of the DVD used to restrict playback of the disc according to the age of the user and the restriction level in each country. The restriction varies from disc to disc; when it is activated, playback can be completely prohibited, violent scenes are skipped or replaced with other scenes, and so on.

Progressive scan

Compared to standard interlace mode that alternatively shows every other line of an image to create one frame, progressive scan shows the entire image at once as a single frame. This means that while interlace mode can show 30 frames per second, progressive scan can show 60. The overall picture quality increases and still images, text and horizontal lines appear sharper.

Title (page 19)

The longest section of a movie or a music piece on a DVD; a movie, etc., for a picture piece on video software; or an album, etc., for a music piece on audio software. Each title is assigned a title number enabling you to locate the title you want.

Refer to the enclosed document regarding warranty that is country/area-specific.



為了避免發生火災或觸電，請勿讓本機淋雨或放在潮濕的地方。

為了避免發生火災或觸電，請勿將倒入液體的容器放置於主機上。

為了避免觸電，請勿擅自打開機殼。維修應委託持有執照的專業技術人員進行。

注意

使用本機中的光學儀器將增加對眼睛的傷害，因此不可擅自拆卸機殼。維修應委託持有執照的專業技術人員進行。

使用 PlayStation®2 前務必閱讀以下的注意事項

有極少部分的人，當看到閃光或受強烈的光線照射時會引發癲癇或昏迷等症狀。這種人當觀看電視（包括 DVD）或觀看如這架 PlayStation®2 等遊戲機的畫面時，有時會出現癲癇發作的情形。即使至今未曾有過類似發作經驗的人，亦有遭遇上述症狀之可能。

如果您過去曾經罹患癲癇，或是曾經有過眼花撩亂、痙攣、癱瘓、昏迷不醒、精神錯亂或極度興奮等發作經驗的話，在使用本機之前，請先接受醫生的診斷治療。

某些 PlayStation® 規格之軟件在 PlayStation®2 主機上執行時，可能會出現某些操作與使用 PlayStation® 主機時有差異，或是無法在 PlayStation®2 主機上正常執行之情形。如果您需要更多資訊，請就近與保證書上記載的消費者服務中心聯繫以獲得技術方面之援助。

關於安全

本產品是在充分重視安全性能的情況下設計的。但如果使用不當，任何電器產品都有可能引起火災、觸電或人身傷害的潛在危險。為確保安全操作，請遵循以下各項規則：

- 查閱所有警告條文、注意事項及使用說明。
- 如果裝置出現動作不正常，或者發出異常聲音或氣味時，請立即停止使用。
- 如果裝置發生故障，請打電話給保證書上記載的消費者服務中心。

使用和保養

- 請勿投擲或掉落主機，也不可使其受到強烈的外力撞擊。
- 請勿將主機放在不平穩、傾斜或易受振動的地方。
- 在主機已經接通電源的情況下，切勿搬動主機或改變主機的位置。
- 請勿將主機放在高溫多濕或日光直射的地方（使用溫度範圍為 5°C–35°C）。
- 請勿將主機放在溫度有急劇變化的地方（例如每小時的溫度差達到或超過 10°C 的地方）。
- 請勿將主機放在窗戶密閉的車內（特別是夏天），因為這可能導致本產品表面變形或發生故障。
- 請勿在灰塵積聚的地方使用主機。
- 請勿讓液體或異物進入主機內。
- 請勿將主機放在靠近於產生磁場的磁鐵、揚聲器或電視機等的地方。
- 請勿在主機上放置重物。
- 請勿觸摸主機各端子的金屬部分，也不可讓異物進入主機各端子內。
- 如果長期不打算使用主機的話，請將 PlayStation®2 主機的電源插頭從牆壁插座拔下。
- 請握住插頭部分從牆壁插座拔下電源插頭，切勿拉扯電源線。
- 請勿將橡膠或塑膠製品長期放置於主機表面，這樣可能損壞產品的塑膠表面。
- 為防止用眼過度，遊玩時請每小時休息 15 分鐘左右。
- 請務必使用附帶的交流電源線。
- 移動主機前，請先拔下所有的連接線。

檢查交流電源線

為幫助確保本產品的安全操作，請定期檢查交流電源線有無破損。若發現電源線有損壞，請立即中止使用，並與保證書上記載的消費者服務中心聯繫。

請勿觸摸主機的各端子

請勿觸摸主機各端子的金屬部分，也不可將異物放入主機各端子內。

請勿將主機放置於充滿香煙煙霧或煙灰的地方。設置主機時，請避免將其放在有過多香煙煙霧或煙灰聚集的地方。殘留在透鏡等內部零件上的香煙煙霧或煙灰可能會導致主機發生故障。

清潔通風孔

灰塵容易聚集在 PlayStation®2 主機的前後通風孔。請經常檢查通風孔，並使用低功率吸塵器清除聚集的灰塵。

光碟的保養

- 請勿把光碟放在高溫多濕或日光直射的地方。
- 不使用時，請把光碟放在光碟盒內。堆放或不規整地放置在盒外的話，可能會使光碟變形。
- 請勿觸摸光碟表面，取碟時請拿光碟的邊緣部分。
- 請勿在光碟上粘貼紙張或膠帶。
- 請勿用油性筆或原子筆等在光碟表面寫字或畫圖。
- 光碟上的指紋、灰塵、污垢或刮痕會導致圖像扭曲或音質下降。平時請仔細保養光碟，確保光碟在使用前清潔光亮。
- 請使用乾淨軟布從中心向外輕輕擦拭光碟。
- 擦拭光碟時，請勿使用輕油精等非 CD 專用的市售清潔劑或用於 LP 唱片的防靜電噴霧劑等，以免損壞光碟。

關於結露現象

若把主機或光碟從寒冷的地方直接搬到溫暖的場所，機內的透鏡或光碟上會凝結水氣。若發生此現象，主機可能不正常工作。在這種情況下，請把光碟取出，放置數小時直至水氣蒸發後再放回使用。如果主機仍無法恢復正常操作的話，請打電話給保證書上記載的消費者服務中心。

清潔主機

- 清潔主機前，為安全起見，請務必 1) 按主機背面的 MAIN POWER（主電源）按鈕關閉 PlayStation®2 主機的電源，2) 從牆壁插座拔下電源插頭。
- 請勿使用稀釋溶劑或其它化學藥劑來清潔主機外殼，因為這些劑品可能損傷本產品表面。使用市售的清潔布時，請參照該清潔布的使用說明。
 - 當需要清潔主機外殼時，請以用水稀釋過的中性清潔劑濕潤軟布，用力絞去軟布上過剩的液體後擦拭外殼的污痕，最後再用幹布擦淨。

切勿分解或改造主機

- 請按照使用說明書操作 PlayStation®2 主機。嚴禁擅自分解或改造 PlayStation®2 主機，禁止分解和使用其電路結構。
- 用戶不可自行維修 PlayStation®2 主機內的各部品。擅自分解主機將喪失所有保障權益，同時還可能有受輻射線傷害或觸電的危險。

PlayStation®2 的對應光碟

使用類比控制器 (DUALSHOCK®2) * 時的安全注意事項

- 在使用類比控制器 (DUALSHOCK®2) 時, 如果開始感覺疲勞, 手或手臂感覺不適或疼痛時, 請立即停止使用主機。如果情況無好轉, 請接受醫生的診療。
- 除了用手以外, 請勿嘗試用任何其他方法操作類比控制器 (DUALSHOCK®2)。請勿讓控制器接觸頭部、臉部或靠近身體任何其他部位的骨骼。
- 類比控制器 (DUALSHOCK®2) 的震動功能會加重傷勢。如果手或手臂的骨骼或關節有病狀的話, 請勿使用震動功能。請注意, 有些 PlayStation®2 規格之軟件或 PlayStation® 規格之軟件的初期設定將震動功能設定為「開」。在大多數情況下, 您可通過軟件的選項選單將震動功能設定為「關」。使用類比控制器 (DUALSHOCK®2) 操作這類軟件之前, 請務必將震動功能設定為「關」。
- 請避免連續長時間使用類比控制器 (DUALSHOCK®2)。每 30 分鐘休息一次為宜。
- * 以上注意事項同樣適用於類比控制器 (DUALSHOCK®) 的使用。

	PlayStation®2 規格之 DVD-ROM	PlayStation®2 規格之 CD-ROM	PlayStation® 規格之 CD-ROM
光碟標誌	“  ”, PlayStation®2 和  標誌	“  ”, PlayStation®2 和  標誌	PlayStation® 和  標誌
光碟顏色	銀色	藍色	黑色
內容	聲音 + 影像		
光碟尺寸	12 cm		

	音樂 CD		DVD (數碼影音光碟) * ³		DVD-RW (VR 模式)	
光碟標誌						
內容	聲音		聲音 + 影像		聲音 + 影像	
光碟尺寸	12 cm	8 cm* ¹ (單曲 CD)	12 cm	8 cm* ²	12 cm	8 cm* ²



* DVD VIDEO® 和 “DVD-RW” 標誌為商標。

*¹ 注意：垂直豎立主機時, 如果要播放 8cm 音樂 CD, 必須另外準備光碟固定架 (選購品)。

*² 要播放 8 cm DVD 或 DVD-RW 光碟時, 您必須水平橫放主機。

*³ 「DVD (數碼影音光碟)」是指 DVD-VIDEO、DVD-R、DVD+R 和 DVD+RW 光碟, 以及以視頻模式錄製的 DVD-RW 光碟。

本機所能播放的 DVD 系統之區域碼

- 本機可以播放 NTSC 制式的光碟, 而無法播放其他制式規格 (例如 PAL、SECAM) 的光碟。
- DVD (數碼影音光碟) 上都標有  之類的區域碼。DVD (數碼影音光碟) 只能在標示相同號碼的影碟機上播放。區域碼非為「3」的 DVD (數碼影音光碟) 無法使用本機播放。
- 本機也能播放標有  的 DVD (數碼影音光碟) 如果試圖播放除此之外的光碟, 畫面上會出現「由於地區限制, 本光碟無法播放。」的字句。

- 有些未印上區域碼的 DVD, 仍可能會受到地區限制而無法播放。

播放 DVD-R/DVD-RW/DVD+R/DVD+RW 光碟* 的注意事項

有些用 DVD-R/DVD-RW/DVD+R/DVD+RW 錄製裝置製作的光碟可能因刮痕、污垢、灰塵、指紋或錄製過程中遇到的問題, 或者因為錄製時的光碟狀態而無法進行播放。只有在錄製後進行了最終化操作處理 (結束錄製的一個過程) 的光碟才可以播放。

利用「只能複製一次」功能錄製在支援 CPRM (可記錄媒體之內容保護) 技術的 DVD-RW 光碟上的

影像部分將無法播放, 並會顯示出「播放功能受到限制, 無法進行播放。」的字句。詳細內容請參閱 DVD 錄製裝置附帶的說明書。(CPRM 是對錄製了「只能複製一次」的節目具有加密功能的防複製技術。)

* 關於各種類型的 DVD 之詳細內容, 請參閱本使用說明書第 27 頁的「術語解說」。

關於特殊形狀的光碟

請勿使用心形或星形等不規則形狀的 CD, 因為這類 CD 可能會導致本機發生故障。

播放 DVD 時的注意事項

- 某些 DVD 的播放操作方法會因為影片製作者的特殊意圖而受到部分限制。本機乃根據影片製作者設計的光碟內容進行播放, 若出現無法配合操作而起動各項機能之現象, 恕不預先告知。詳細請同時參閱該 DVD 附帶的使用說明書。
- 因為生產過程上的問題或加密技術而發生在 PlayStation®2 主機上無法正常操作是非常罕見的特例。假如您遭遇到這類問題, 請先嘗試重新播放。如果問題仍然無法解決, 請詢問 DVD 的發售廠商尋求更多相關資訊或連絡保證書上記載的消費者服務中心。

	警告	2
	使用前須知事項	2
	開始使用之前 PlayStation®2 的對應光碟	3
	檢查包裝內容	4
	各部名稱	5
	放置主機	5
	連接主機和電視機	6
	連接搭配數碼端子的音響設備	7
	連接其他數碼設備	8
	使用主選單	8
	連接	
	開始玩遊戲	10
	使用 MEMORY CARD (記憶卡)	12
	播放音樂 CD	12
	播放 DVD	14
	DVD 播放裝置的設定和調整	18
	故障檢修	25
	規格	26
	術語解說	27
	維修責任	27
其他資訊		



請檢查和確認箱子內是否具備以下物品：

- PlayStation®2 主機
- 類比控制器 (DUALSHOCK®2)
- AV 連接線 (音頻/視頻一體化)
- 交流電源線 (附 3 插針電源插頭轉換器)

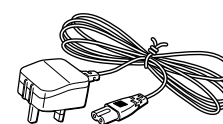
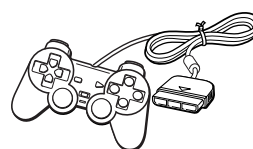
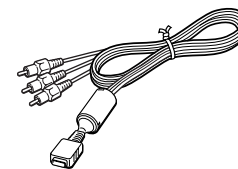
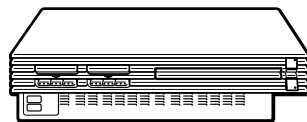

- 使用說明書 (1 套)
- 跑車浪漫旅™4 “序章” 版 (1 片)

3 插針電源插頭轉換器之拆取

牆壁電源插座形狀依使用地區而異，因此若您操作 PlayStation®2 的地區之插座形狀不適合您使用時，請拆掉電源插頭轉換器。

- 1 擰開螺絲釘。
- 2 打開電源插頭轉換器。

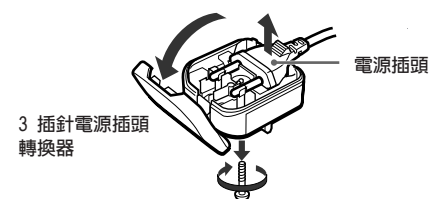

如果欠缺任何物品，請就近與保證書上記載的消費者服務中心聯繫。

PlayStation®2主機

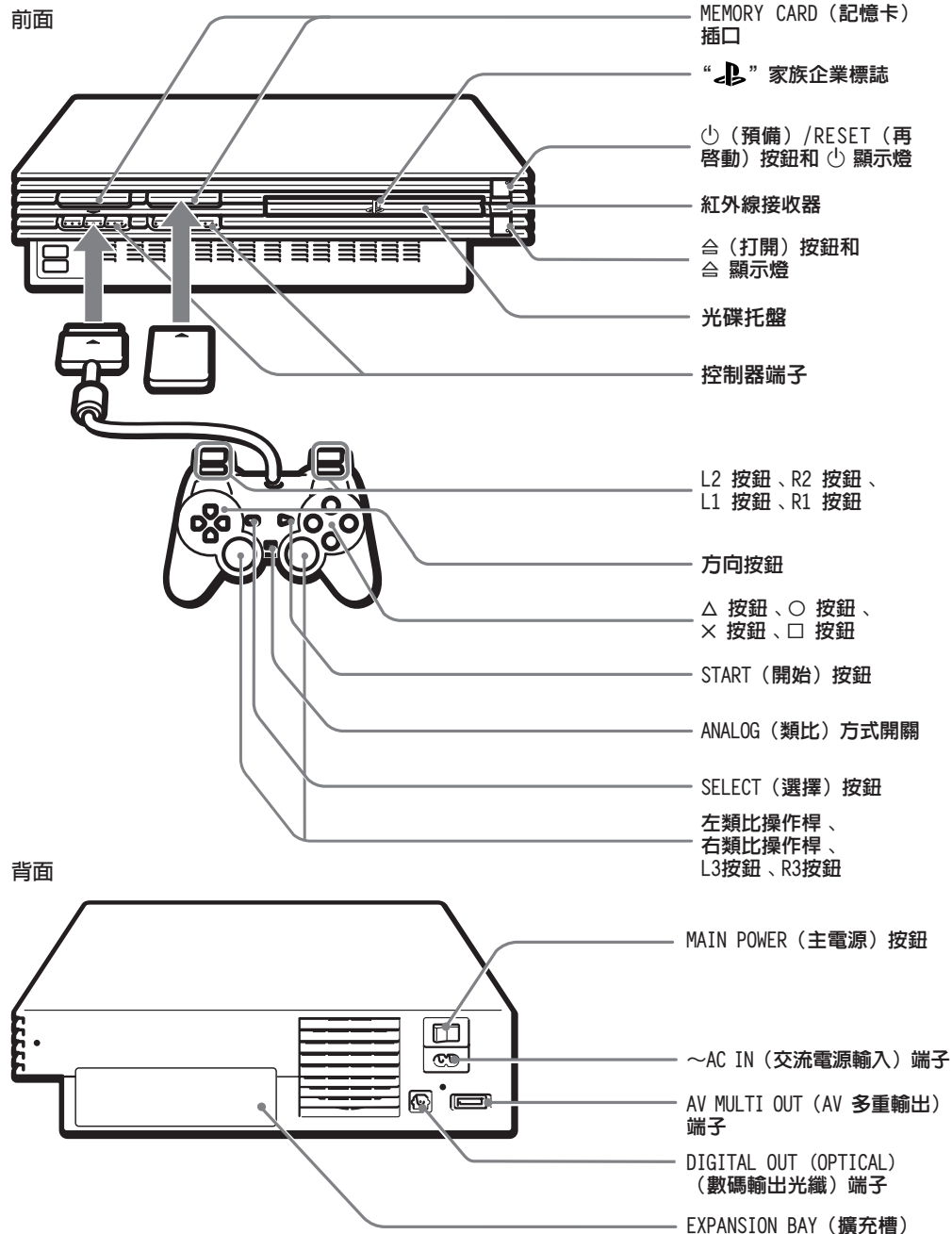

您可以垂直或水平放置主機。當垂直放置時，建議您使用 PlayStation®2 專用直立架 SCPH-10040 G (選購品)。如果沒有 PlayStation®2 專用直立架，請如下圖所示地水平放置主機。當水平放置時，建議您使用 PlayStation®2 專用橫放架 SCPH-10110 G (選購品)。

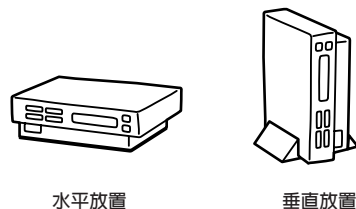

光碟托盤上的“PS”家族企業標誌
您可以配合主機的放置方式，旋轉光碟托盤上的“PS”家族企業標誌。

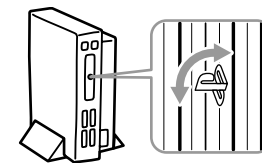

注意事項

- 水平或垂直以外的傾斜放置，可能會造成主機的損壞。
- 操作主機時請勿擅自更改主機的放置方式（由原先的水平放置變成垂直放置。或反之），否則會損壞光碟或導致主機故障。

如下所述，您可使用本機附屬品的 AV 連接線（音頻／視頻一體化）把 PlayStation®2 主機連接到具有影像／聲音輸入端子的電視機上。亦可利用其他特殊的連接線或轉換器（皆為選購品），連接其他類型的電視機。詳細內容請參閱以下各部分的說明。

- 連接具有 S 影像輸入端子的電視機
- 連接具有影像色差輸入端子的電視機

有關上述各部分的說明均假設通過電視機揚聲器輸出聲音。

連接具有影像／聲音輸入端子的電視機時

您可使用本機附屬品的 AV 連接線（音頻／視頻一體化）把 PlayStation®2 連接到有影像／聲音輸入端子的電視機上。

連接時，請注意端子顏色要插入電視機上相同顏色的端子插孔；黃色（影像）端子插入黃色端子插孔、紅色（右聲道）端子插入紅色端子插孔、白色（左聲道）插入白色端子插孔。

連接完畢之後

請替電視機設定正確的影像輸入頻道（參閱電視機的使用說明書）。

連接寬螢幕（長寬比 16：9）電視機時

請將「系統設定」選單的「螢幕尺寸」設定為「16：9」。關於系統設定的詳細說明，請參考第 8-9 頁的說明。

如果您的電視機是單聲道

請勿連接紅色端子。若要從單聲道電視機收聽左右兩邊的聲音，請選用市售的雙音頻對單音頻（立體聲對單聲道）型音頻連接線（非附屬品）。

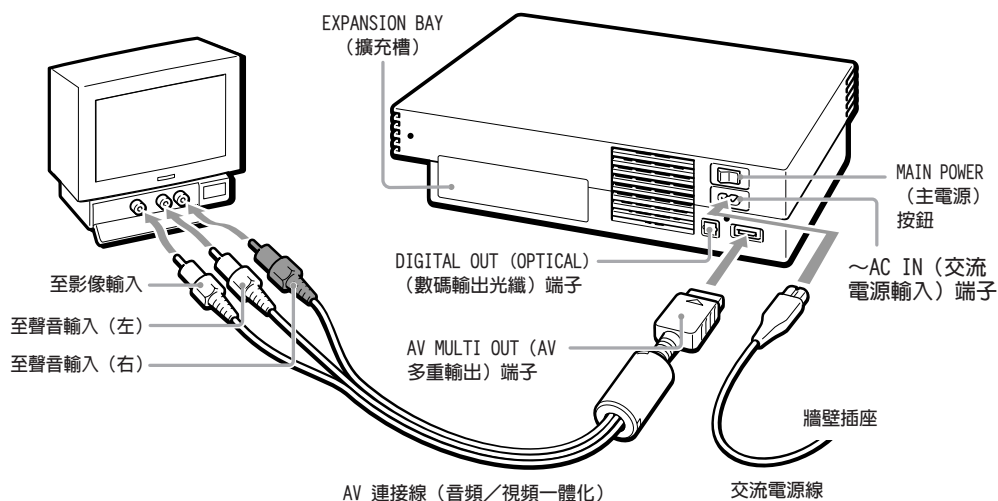

連接錄影機時

您可使用本機附屬品的 AV 連接線（音頻／視頻一體化）把 PlayStation®2 主機連接到錄影機上。連接時，請注意端子顏色要插入電視機上相同顏色的端子插孔。

如果您的電視機是單聲道而非立體聲，則不必連接紅色端子。

當播放 DVD 時，請勿將主機連接到錄影機上，因為這會造成畫質鮮明度的降低。請把主機直接連接到電視機上。

連接完畢之後

替電視機和錄影機設定正確的影像輸入頻道（參閱該電視機以及錄影機的使用說明書）。

播放 DVD（數碼影音光碟）時

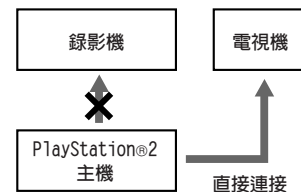

連接具有 S 影像輸入端子的電視機時

讓 PlayStation®2 主機通過 S 視頻連接線 SCPH-10060 G（選購品）連接電視機，可強化畫質之鮮明度。

連接完畢之後

替電視機設定正確的影像輸入方式（例如「S VIDEO（S 視頻）」）。

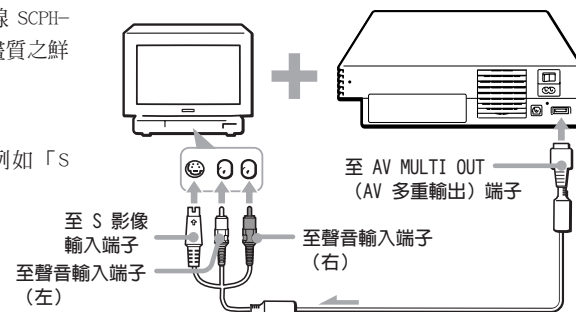

連接具有影像色差輸入端子的電視機時

如果您的電視機或錄影機具備影像色差輸入端子時，建議您使用 PlayStation®2 專用影像色差連接線 SCPH-10100 G (選購品) 連接電視機，如此您將可獲得更傳真的鮮明影像。

連接前

使用 PlayStation®2 專用影像色差連接線連接電視機前，如果沒有先將「系統設定」選單的「影像色差輸出」選項設定為「Y Cb/Pb Cr/Pr」，電視畫面可能不正常顯示。請先使用附屬的 AV 連接線 (音頻/視頻一體化)，確認「系統設定」選單的「影像色差輸出」選項是設定為「Y Cb/Pb Cr/Pr」之後再使用 PlayStation®2 專用影像色差連接線進行連接。

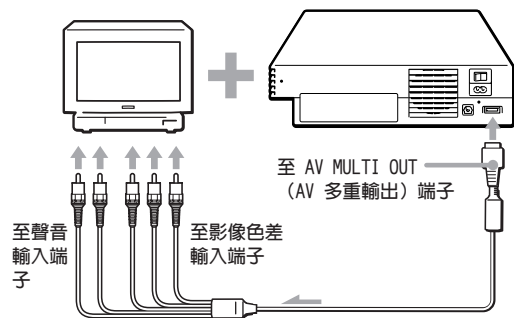

注意事項

- PlayStation®2 主機不直接相容 HDTV (高畫質電視)，您必須另外準備對應軟件及連接裝置。
 - 您必須使用影像色差連接線才能以逐行掃描觀看 DVD。如果選擇逐行掃描後畫質下降，請選擇通常的隔行掃描模式觀看。詳細內容請參閱第 9 頁的「Progressive (逐行掃描)」。
- 詳細請參閱電視機的使用說明書。

靜止畫面的注意事項

DVD 選單、標題選單及本機的設定畫面等靜止畫面假如長時間顯示在電視機上，有可能發生影像出現模糊的殘像問題。特別是液晶方式以外的螢幕投影電視相當容易發生上述問題，因此您最好避免使用該類電視機。

畫面跳動現象注意事項

有部分電視機或錄影機連接 PlayStation®2 主機後，畫面會發生上下跳動現象。遇此情形時，建議您將 PlayStation®2 連接到其他電視機上。如果畫面失真現象仍舊無法解決，請聯絡保證書上記載的消費者服務中心。

利用數碼連接線 (Dolby Digital optical (AC-3) = 杜比數碼 (AC-3) 光纖) 連接 PlayStation®2 主機的音響端子，通過數碼接收器 (擴大機) 及喇叭 (揚聲器)，您便可以欣賞更逼真的多聲道環繞音效。

利用數碼連接線連接接收器 (擴大器)、MD (迷你光碟) 及 DAT (數位聲音錄音帶) 時

您需要使用市面上販賣的數碼輸出光纖連接線，並調整「系統設定」選單的「DIGITAL OUT (OPTICAL)」(數碼輸出光纖) 選項，設定為「開」(購買時的初期設定)。系統設定選單之詳細設定方法，請參考第 8-9 頁的說明。

PlayStation®2 主機背面

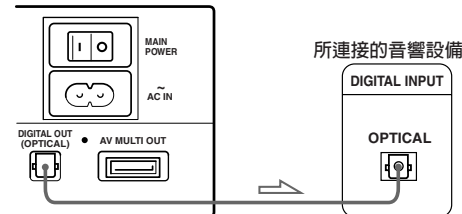

注意事項

- 連接時，請同時參閱音響設備的使用說明書，以確保正確使用。
- 您無法使用 MD 或 DAT 機從採用 Dolby Digital、DTS 或 MPEG 音頻格式的光碟直接錄製數碼格式音頻。

連接內建 DTS*、Dolby Digital (杜比數碼 AC-3)** 或 MPEG 解碼器 (僅限 DVD) 的音響設備

連接內建 DTS、Dolby Digital (杜比數碼 AC-3) 或 MPEG 解碼器的音響設備 (選購品)，您可欣賞到 DVD 中，以 Dolby Digital (杜比數碼 AC-3)、DTS 格式或 MPEG 格式錄製的逼真音效，而享受到有如置身電影院或演唱會場般的臨場效果。

使用市面上販賣的數碼輸出光纖連接線，插入主機 DIGITAL OUT (OPTICAL) (數碼輸出光纖) 端子連接音響設備。

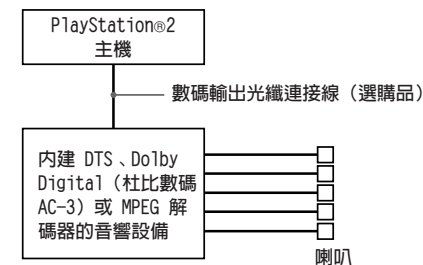

PlayStation®2 主機之 DVD 播放裝置的設定當 DVD 播放裝置要經由音響設備播放聲音時，您必須做某些必要的設定變更。詳細的設定方法，請參閱第 18-24 頁「DVD 播放裝置的設定和調整」的說明。

- 當您連接內建 DTS 解碼器的音響設備時
開啓「聲音設定」選單後，將「DIGITAL OUT (OPTICAL)」(數碼輸出光纖) 設定為「開」，然後將「DTS」設定為「開」。
- 當您連接內建 Dolby Digital (杜比數碼 AC-3) 解碼器的音響設備時
開啓「聲音設定」選單後，將「DIGITAL OUT (OPTICAL)」(數碼輸出光纖) 設定為「開」，然後將「Dolby Digital」設定為「開」。
- 當您連接內建 MPEG 解碼器的音響設備時
開啓「聲音設定」選單後，將「DIGITAL OUT (OPTICAL)」(數碼輸出光纖) 設定為「開」，然後將「MPEG」設定為「開」。

注意事項

當連接音響設備時，請同時參閱該音響的使用說明，正確連接。

* “DTS”、“DTS Digital Out”是 Digital Theater System, Inc. 的商標。
** 本製品經杜比實驗室授權生產。“杜比”、“Dolby”和雙 D 標誌是杜比實驗室的商標。非公開機密著作物。©1992-1997 Dolby Laboratories. (杜比實驗室) 版權所有。

經由 USB (Universal Serial Bus) 連接埠連接其他設備

經由 USB 連接埠，本機可連接其他支援 USB 的周邊設備。連接時，請同時參閱該產品的使用說明書，正確連接。

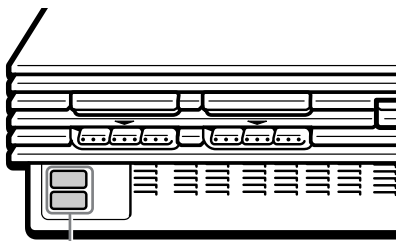

USB 連接埠

注意事項

並非所有支援 USB 的周邊設備都適用於 PlayStation®2 主機。使用時，請同時參閱該機器的使用說明書。

第一次接通電源啟動主機時，螢幕上會出現提示您調整語言和時間等初期設定的畫面。這些設定以後可以通過系統設定選單進行修改。詳細內容請參考第 8-9 頁的「使用系統設定選單」。設定完畢後，當您沒有放入光碟就啟動主機時，螢幕上就會出現如下的主選單。



您可以選擇從主選單進入「瀏覽器」介面或「系統設定」選單。

使用「瀏覽器」介面

進入「瀏覽器」介面後可以執行下列幾項操作。

- 檢查／拷貝／刪除保存在 PlayStation®2 專用 MEMORY CARD (記憶卡) (8MB) 或 MEMORY CARD (記憶卡) 中的遊戲資料
- 啟動 PlayStation® 或 PlayStation®2 規格之軟件
- 播放音樂 CD
- 播放 DVD (數碼影音光碟)

用方向按鈕之上下按鈕，選擇「瀏覽器」，按 X 按鈕決定。

螢幕上會出現「瀏覽器」介面，並顯示目前被插在主機上的 PlayStation®2 專用 MEMORY CARD (記憶卡) (8MB)、MEMORY CARD (記憶卡) 以及光碟的圖標。

檢查／拷貝／刪除資料

您可以將儲存在 PlayStation®2 專用 MEMORY CARD (記憶卡) (8MB) 或 MEMORY CARD (記憶卡) 中的遊戲資料拷貝到別的記憶卡裡，不用的資料也可以自行刪除。不過您無法將 PlayStation®2 規格之軟件的遊戲資料拷貝到 MEMORY CARD (記憶卡) SCPH-1020 HI 內。將 PlayStation®2 專用 MEMORY CARD (記憶卡) (8MB) 或 MEMORY CARD (記憶卡) 插在主機上。

1 確認您想要檢查／拷貝／刪除的遊戲資料，選擇 PlayStation®2 專用 MEMORY CARD (記憶卡) (8MB) 或 MEMORY CARD (記憶卡) 的圖標後，按 X 按鈕決定。

2 依照畫面指示，檢查／拷貝／刪除資料。

注意事項

在執行拷貝或刪除遊戲資料的過程中，切勿拔起或插入 PlayStation®2 專用 MEMORY CARD (記憶卡) (8MB)、MEMORY CARD (記憶卡)。

如何使用「系統設定」選單

您可以使用「系統設定」選單修改或更新 PlayStation®2 主機的個人系統設定。

以下這些個人設定並不會因為電源的關閉而消滅，且會繼續地被保存於主機內。

購買時的初期設定標有下線。

1 用方向按鈕之上下按鈕，選擇「系統設定」，按 X 按鈕決定。

螢幕上會出現「系統設定」選單。

2 用方向按鈕之上下按鈕，選擇您想要修改的項目，按 X 按鈕決定。

■ 調整時鐘

設定現在時刻。

1 用方向按鈕之上下，調整年份後按方向按鈕之右按鈕決定執行。

請用上述方法分別設定月份、日期、小時、分、秒。要回到先前的項目時，按方向按鈕之左按鈕。

2 按 X 按鈕啟動時鐘。

選擇時鐘的顯示方式

用方向按鈕之上下，選擇「調整時鐘」後按 Δ 按鈕，您即可設定顯示方式。

時間顯示方式

- 12 小時制
- 24 小時制

日期顯示方式

- 月/日/年
- 日/月/年
- 年/月/日

時區設定

設定目前的所在時區。

夏令時間

如有必要，您可選擇本項目設定「夏令時間」。

- 標準時間
- 夏令時間

■ 螢幕尺寸

選擇所連接的電視機的縱寬比。

- 4:3：使用普通電視機時的標準設定。
- 全畫面：使用普通電視機時，寬螢幕規格的影像會自動顯示在整個螢幕上，但左右兩邊的部份將被切割。
- 16:9：使用寬螢幕規格的電視機時的標準設定。

■ DIGITAL OUT (OPTICAL) (數碼輸出光纖)

選擇是否使用 DIGITAL OUT (OPTICAL) (數碼輸出光纖) 傳送聲音信號。

- 開：使用數碼輸出光纖連接線 (選購品) 傳送時，通常的標準設定。
- 關：不使用數碼輸出光纖端子傳送聲音信號時。

■ 影像色差輸出

當您利用 RGB 連接線或影像色差連接線 (皆為選購品) 連接您府上的電視機、錄影機或顯示器時，請修改本項設定。

假如您是使用附屬的 AV 連接線 (音頻/視頻一體化) 或 S 視頻連接線連接主機，則不需要做任何變更修改。

- Y_Cb/Pb_Cr/Pr：透過影像色差輸入端子連接時。
- RGB：透過 RGB 輸入端子連接時。

注意事項

您可以選擇使用 RGB 輸出或影像色差輸出來播放 PlayStation® 或 PlayStation®2 規格之軟件。但 PlayStation®2 主機之「系統設定」選單的「影像色差輸出」設定並無法適用到所有對應光碟。當播放 DVD (數碼影音光碟) 時會自動選擇影像色差輸出 (Y, Cb/Pb, Cr/Pr)。

■ 遙控器

選擇使用 PlayStation®2 專用 DVD 遙控器 (選購品) 進行操作。

- 遊戲操作功能 開：使用 DVD 遙控器操作 PlayStation®2 規格之軟件或 PlayStation® 規格之軟件時，選擇此項設定。
- 遊戲操作功能 關：不使用 DVD 遙控器操作 PlayStation®2 規格之軟件或 PlayStation® 規格之軟件時。

注意事項

- 將遙控器設定為「遊戲操作功能 開」時，如果從控制器端子 1 拔下控制器，某些 PlayStation®2 規格之軟件或 PlayStation® 規格之軟件可能會停止運作。若出現這種情況，請將設定改為「遊戲操作功能 關」。
- 本 DVD 遙控器可能會出現無法支援現有 PlayStation®2 規格或 PlayStation® 規格之軟件的遊戲操作功能。另外，同時按下多顆遙控器按鈕可能會導致 DVD 遙控器無法正常運作。

■ 語言

選擇螢幕的顯示語言。

- 英文
- 繁體中文

確認版本

您可確認版本及各種設定。

在主選單畫面上按 Δ 按鈕則出現版本的畫面。

初期設定標有下線。

■ 自動診斷

命令主機自動調整光碟的運轉到最佳狀態之功能的設定。但是，當自動診斷設定為「開」時，主機進行追加調整，有可能使原先無法播放的光碟可以進行播放。

自動診斷

- 開
- 關

1 用方向按鈕之上下按鈕，選擇

「主機」後，按 Δ 按鈕決定。

2 用方向按鈕之上下按鈕，選擇「開」後，按 \times 按鈕執行。

3 放入光碟。

主機開始自動診斷。

注意事項

當您按下 O (預備)/RESET (再啟動) 按鈕、或放入 PlayStation®2 規格、PlayStation® 規格之軟件、DVD (數碼影音光碟) 時，自動診斷功能會自動跳回「關」(購買時的初期設定)。

■ PlayStation® 驅動程式

PlayStation® 驅動程式指的是一個用來讀取 PlayStation® 規格軟件的系統程式。

光碟讀取速度

- 標準：通常的標準設定。
- 高速：縮短 PlayStation® 規格之軟件的載入時間。但在使用一部分，高速效果不明顯或無法高度讀取的軟件時，請選擇「標準」以確保光碟的正常運作。

材質貼圖

- 標準：通常的標準設定。
- 平滑補正：自動修補 PlayStation® 規格之軟件的部分粗糙圖像。但在使用一部份無法平滑補正的軟件時，請選擇「標準」。

1 用方向按鈕之上下按鈕，選擇「PlayStation® 驅動程式」後，按 Δ 按鈕執行。

2 用方向按鈕之上下按鈕，指定您想要執行的功能後，按 \times 按鈕決定。

注意事項

當您按下 O (預備)/RESET (再啟動) 按鈕、或關閉電源後，PlayStation® 驅動程式的設定會自動跳回「標準」(購買時的初期設定)。

■ 解除 Progressive (逐行掃描) 設定

您可解除 DVD 播放裝置的 Progressive (逐行掃描) 設定。

Progressive 設定

- 不解除
- 解除

1 用方向按鈕選擇「DVD 播放裝置」後，按 Δ 按鈕執行。

2 按 \times 按鈕決定。

3 用方向按鈕選擇「解除」後，按 \times 按鈕決定。

Progressive 設定不會在關機後立刻解除。設定將在 DVD 光碟開始播放時才被解除。

4 按 O 按鈕返回主選單後用方向按鈕選擇「瀏覽器」後，按 \times 按鈕。

5 用方向按鈕選擇 DVD video 圖標後，按 \times 按鈕。

DVD 播放裝置的 Progressive 設定被解除，開始播放。

注意事項

- 此設定僅在「Progressive」設定為「開」時才能被解除。當「Progressive」設定為「關」時，則不會出現在 DVD 播放裝置的選單中。
- 關於將「Progressive」設定為「開」的詳細情況，請參閱第 21 頁的「DVD 播放裝置的設定和調整」的「Progressive (逐行掃描)」部分。
- 如果在完成上述步驟 5 之前出現下列情況，則 Progressive 設定不會被解除：
 - 按了 O (預備)/RESET (再啟動) 按鈕。
 - 用主機背面的 MAIN POWER (主電源) 按鈕關閉了主機電源。



遊玩的第一步

- 1** 按主機背面的 MAIN POWER (主電源) 按鈕，接通電源。

當主機前面的 ⏻ (預備) 顯示燈亮紅燈時，代表本機目前處於預備狀態。

- 2** 按 ⏻ (預備) / RESET (再啟動) 按鈕。

⏻ (預備) 顯示燈亮綠燈，螢幕上出現啟動畫面。

- 3** 將類比控制器 (DUALSHOCK®2) 插入主機的控制器端子。

- 4** 按 ⏻ (打開) 按鈕。

打開光碟托盤。

- 5** 使標籤之面朝上，將光碟放入托盤。

- 6** 按 ⏻ (打開) 按鈕。

關閉托盤。螢幕上出現 ② 或 ③ 畫面，代表進入待機狀態。

注意事項

類比控制器 (DUALSHOCK®2) 或類比控制器 (DUALSHOCK®) 對應軟件的設定方法，請參考第 11 頁「方式轉換和方式顯示燈」的說明。詳細情況請參閱遊戲說明書。

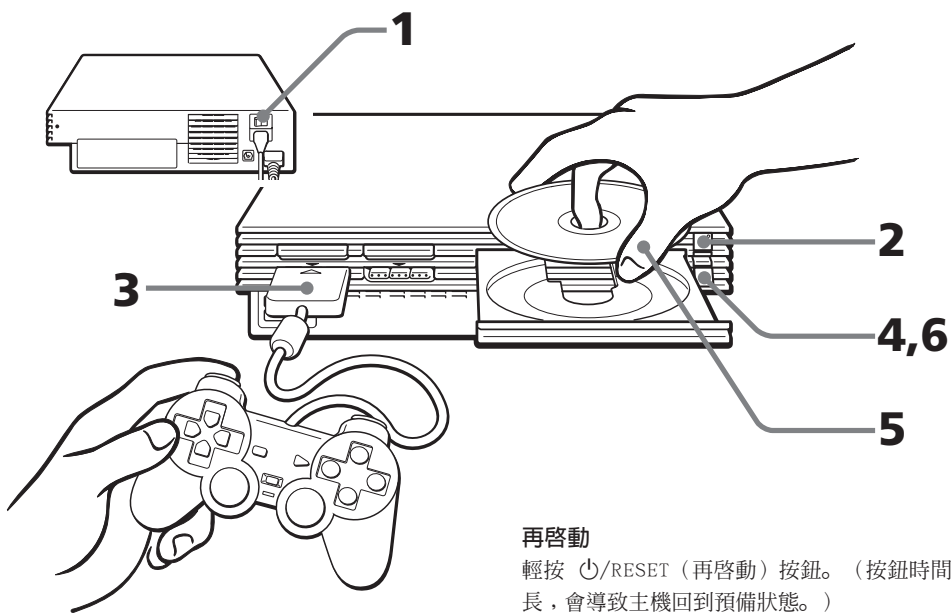

再啟動

輕按 ⏻ / RESET (再啟動) 按鈕。(按鈕時間過長，會導致主機回到預備狀態。) 在遊玩途中按該按鈕，會強制結束遊戲並喪失所有當時尚未保存的遊戲資料，敬請注意。

顯示啟動畫面

沒有放入光碟就接通電源時
螢幕上出現 ① 畫面。

- 於出現 ① 畫面後插入一片 PlayStation®2 規格或 PlayStation® 規格的軟件，螢幕上會顯示 ② 或 ③ 畫面，代表您可以開始玩遊戲。
- 您可以選擇從 ① 畫面切換進入「系統設定」選單或「瀏覽器」介面。詳細請參考第 8-9 頁「使用主選單」的說明。

當接通電源，主機內已經放入一片光碟時
螢幕會依據光碟的種類而顯示 ② 或 ③、④ 畫面。出現 ④ 畫面時，代表您放入的光碟可能既不是 PlayStation® 規格，亦非 PlayStation®2 規格的軟件。請參考第 3 頁有關光碟類型的說明。

- ① 沒有放入光碟 (主選單)



- ② 已經放入一張 PlayStation®2 規格的 DVD-ROM / CD-ROM



- ③ 已經放入一張 PlayStation® 規格的 CD-ROM



- ④ 您放入了一張 PlayStation®2 主機無法播放的光碟



結束遊戲

- 1** 按 ⏻ (打開) 按鈕。

打開光碟托盤。

- 2** 取出光碟。

- 3** 按 ⏻ (打開) 按鈕。

關閉托盤。

- 4** ⏻ / RESET (再啟動) 按鈕按住 3 秒鐘以上。

⏻ 顯示燈亮紅燈，主機回到預備狀態。

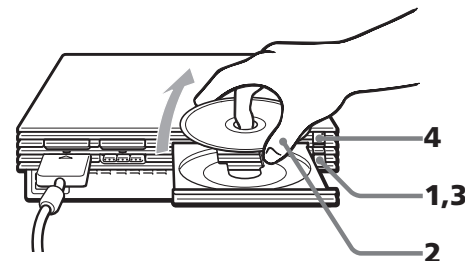

長期不使用本機時

請按主機背面的 MAIN POWER (主電源) 按鈕，關閉電源。並從牆壁插座拔下交流電源線。

嘗試玩其他遊戲

更換光碟並不需要關閉電源。

1 按 (打開) 按鈕。

打開光碟托盤。

2 取出光碟。



3 將另一片光碟放入托盤。

4 按 (打開) 按鈕。

關閉托盤。

5 輕按 (預備) /RESET (再啟動) 按鈕。

(**注意事項**：按鈕時間過長，會導致主機回到預備狀態。)

啟動畫面後顯示  或  畫面，即代表您可以開始玩遊戲。

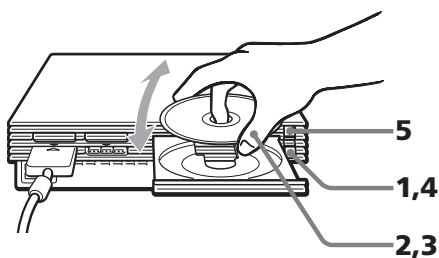





注意事項

當遊玩複數張光碟收錄的遊戲，要更換光碟時，請依照前述之步驟 1~4，正確操作。詳細請參閱遊戲說明書。

使用類比控制器 (DUALSHOCK®2)

- 可對應 PlayStation®2 規格及 PlayStation®規格的軟件。詳細請參閱遊戲說明書。
- 您可以自由選擇數碼方式或類比方式進行操作。選擇類比方式時，可以類比操控以下按鈕。

PlayStation®2 規格的軟件

方向按鈕 /  按鈕、 按鈕、 按鈕、 按鈕 / 左類比操作桿 / 右類比操作桿 / L1、R1、L2、R2 按鈕

PlayStation®規格的軟件

左類比操作桿 / 右類比操作桿

- 您可使用震動功能。

使用類比控制器 (DUALSHOCK®)

(選購品)

- 可對應 PlayStation®2 規格及 PlayStation®規格的軟件。詳細請參閱遊戲說明書。

- 您可以自由選擇數碼方式或類比方式進行操作。選擇類比方式時，可以類比操控左類比操作桿及右類比操作桿。

PlayStation®2 規格的軟件

左類比操作桿 / 右類比操作桿

PlayStation®規格的軟件

左類比操作桿 / 右類比操作桿

- 您可使用震動功能。

方式轉換和方式顯示燈

按 ANALOG (類比) 方式開關，可更改類比控制器 (DUALSHOCK®2) 目前所使用的控制方式。每按一次 ANALOG (類比) 方式開關，都將如下圖般地改變控制方式。

數碼方式 (方式顯示燈：紅燈滅)



類比方式 (方式顯示燈：紅燈亮)

注意事項

使用時請自行選擇適合的模式。

但請注意，某些軟件的設定會優先於方式顯示燈的更改機能，而強制要求更改控制模式。詳細內容請參閱相關的軟件說明書。

震動功能

當使用的軟件支援震動功能時，類比控制器 (DUALSHOCK®2) 能提供玩者有如擬似體驗般的震動效果。震動功能的「開」或「關」請選擇遊戲的選項設定後進行修改。

注意事項

- 長時間不使用類比控制器 (DUALSHOCK®2) 時，請關閉主機電源或從主機上拔下控制器。
- 在使用控制器的震動功能之前，請先閱讀第 3 頁的「使用類比控制器 (DUALSHOCK®2) 時的安全注意事項」。

使用類比控制器 (DUALSHOCK®2)

前

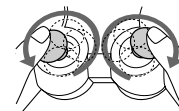

接通主機電源後，請先用拇指如畫圓圈般旋轉一下控制器的操作桿 (如上圖所示)，請不要扭轉操作桿。

數碼方式 (方式顯示燈：紅燈滅)

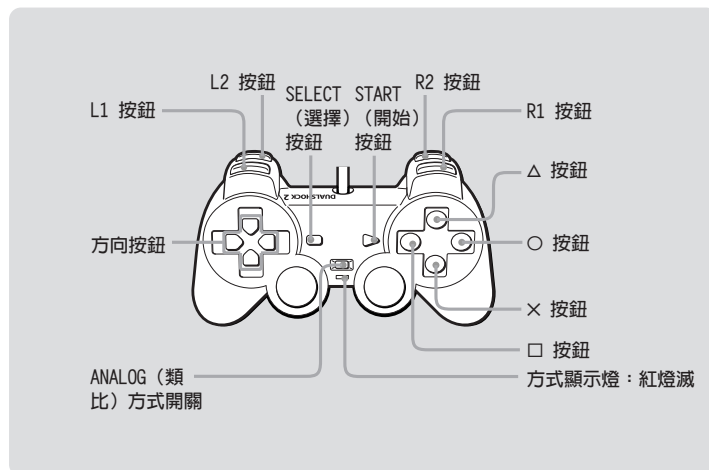

類比方式 (方式顯示燈：紅燈亮)



您可以使用 PlayStation®2 專用 MEMORY CARD (記憶卡) (8MB) 或 MEMORY CARD (記憶卡) (均為選購品) 保存或載入遊戲資料。

PlayStation®2 專用 MEMORY CARD (記憶卡) (8MB) 和 MEMORY CARD (記憶卡) 的不同

當遊玩 PlayStation®2 規格的軟件時，請使用 PlayStation®2 專用 MEMORY CARD (記憶卡) (8MB) (①)。
當遊玩 PlayStation® 規格的軟件時，請使用 MEMORY CARD (記憶卡)。(②)

PlayStation® 主機用來保存遊戲資料的記憶體普通是以「memory blocks (記憶體區塊)」為單位計算，但 PlayStation®2 主機則採用「KB (千位元組)」計算。

* 8 MB = 8,000 KB

① PlayStation®2 專用 MEMORY CARD (記憶卡) (8MB) (選購品)

PlayStation®2 專用 MEMORY CARD (記憶卡) (8MB) 可以保存並且載入 PlayStation®2 規格之軟件的遊戲資料。一塊 PlayStation®2 專用 MEMORY CARD (記憶卡) (8MB) 大約能夠保存 8MB 的遊戲資料，但部分記憶體必須用來保存檔案管理情報。

② MEMORY CARD (記憶卡) (選購品)

MEMORY CARD (記憶卡) 可以保存並且載入 PlayStation® 規格之軟件的遊戲資料。一塊 MEMORY CARD (記憶卡) 大約能夠保存 120KB (15 個記憶體區塊) 的遊戲資料。

注意事項

比 PlayStation®2 專用 MEMORY CARD (記憶卡) (8MB) 或 MEMORY CARD (記憶卡) 內部剩下的空白記憶體更大的遊戲資料是無法保存的。請在開始之前，先查看保存資料時的記憶體必須容量與記憶卡內的空白記憶體容量。保存資料的記憶體必須容量，都記載在各軟件的遊戲解說書等地方。

PlayStation®2 專用 MEMORY CARD (記憶卡) (8MB) 採用 MAGICGATE 技術，該技術通過數據資料加密以有助於保護已獲得著作權之內容。

MAGICGATE 是 SONY 集團開發的著作權保護技術之名稱。

MAGICGATE 不保證與其他印有「MagicGate」標誌之產品間的互換相容性。

插入記憶卡

請箭頭朝上，將 PlayStation®2 專用 MEMORY CARD (記憶卡) (8MB) 或 MEMORY CARD (記憶卡) 插入主機的 MEMORY CARD (記憶卡) 插口。

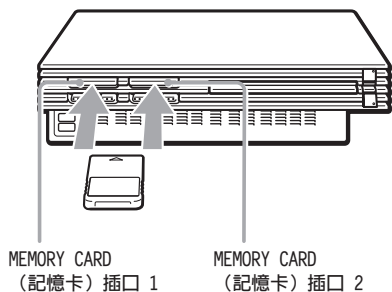

使用多重連接器安裝記憶卡的注意事項

- 在遊玩 PlayStation®2 規格之軟件時，請使用 PlayStation®2 專用 (對戰) 多重連接器 SCPH-10090 G。遊玩 PlayStation® 規格之軟件時，請使用 (對戰) 多重連接器 SCPH-1070 G。
- 當把對應 PlayStation® 的 (對戰) 多重連接器 SCPH-1070 G 插在控制器端子 1 時，請不要將 PlayStation®2 專用 MEMORY CARD (記憶卡) (8MB) 或 MEMORY CARD (記憶卡) 插在 PlayStation®2 主機的 MEMORY CARD (記憶卡) 插口 1 上。插在控制器端子 2 時亦同。否則遊戲資料可能會遭到損壞。

檢查／拷貝／刪除遊戲資料

您可以將保存在 PlayStation®2 專用 MEMORY CARD (記憶卡) (8MB) 或 MEMORY CARD (記憶卡) 中的遊戲資料拷貝到別的記憶卡裡，或是自行刪除不需要的資料。不過您無法將 PlayStation®2 規格之軟件的遊戲資料拷貝到 MEMORY CARD (記憶卡) 內。

您可以進入「瀏覽器」介面，檢查、拷貝或刪除遊戲資料。「瀏覽器」介面上的詳細操作方法，請參考第 8 頁「檢查／拷貝／刪除資料」的說明。

注意事項

您無法在「瀏覽器」介面上直接保存或載入遊戲資料。保存或載入遊戲資料的方法，請參閱遊戲說明書。

播放音樂 CD

- 按 **△** (打開) 按鈕。
打開光碟托盤。
- 使標籤之面朝上，將光碟放入托盤。
- 按 **△** (打開) 按鈕。
關閉托盤。
- 用方向按鈕選擇音樂 CD 圖標後，按 **×** 按鈕。
螢幕上顯示音樂 CD 操作畫面。
- 選擇想要播放的曲目號碼後，按 **×** 按鈕。
播放開始。

結束播放音樂 CD

- 按 **△** (打開) 按鈕。
打開光碟托盤。
- 取出光碟。
- 按 **△** (打開) 按鈕。
關閉光碟托盤。
- 按住 **○** (預備) / RESET (再啟動) 按鈕持續 3 秒鐘以上。
主機進入預備狀態。

操作 CD 播放裝置

您可利用控制介面或直接按類比控制器 (DUALSHOCK®2) 的按鈕來操作 CD 播放裝置。您也可以使用 PlayStation®2 專用 DVD 遙控器 SCPH-10420 G (選購品) 操作 CD 播放裝置。播放光碟時，用方向按鈕選擇 CD 操作畫面上的圖標後，按 × 按鈕。

- ▶ 開始播放
- ⏸ 暫停
- 停止播放
- ◀◀ 倒回播放中歌曲的開頭或上一首曲子的開頭
- ▶▶ 快進
- ◀◀ 快退
- ▶▶ 進到下一首曲子的開頭

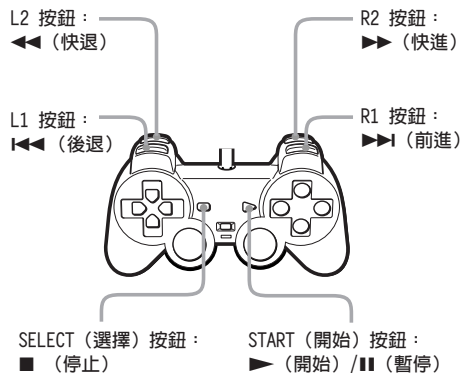

採用保護著作權之加密技術的音樂光碟

本產品的音樂 CD 播放特色是以 Compact Disc (CD) 的標準規格為基準而設計的。最近，有些唱片公司開始銷售採用保護著作權之加密技術的音樂光碟。其中有部分光碟與 CD 的標準規格不一致，因此可能無法在本產品上進行播放。

各種播放模式

您可以選擇各種播放模式。「播放模式」的初期設定為「正常」，「重複」的初期設定為「關」。進入「瀏覽器」介面，選擇音樂 CD 的圖標，按 △ 按鈕即可修改設定。

自己編排播放順序 (編序播放)

- 1 用方向按鈕選擇「播放模式」後，按 × 按鈕執行。
- 2 用方向按鈕選擇「編序」後，按 × 按鈕執行。
- 3 使用方向按鈕選擇要播放的曲目號碼，按 × 按鈕設定。
反覆以上步驟選擇完畢後，即按照指定的順序進行播放。
- 4 按 ○ 按鈕，回到「瀏覽器」介面後，按 × 按鈕開始播放。
- 5 選擇音樂 CD 圖標後按 × 按鈕。
各曲目按已編排的順序顯示於畫面上。選擇您想要播放的曲目號碼後按 × 按鈕。開始播放。

重複播放想要播放的曲目

按照上述 1 至 4 的步驟，然後參照重複播放所有曲目或單一曲目的說明進行操作。詳細內容請參閱本頁的「重複播放所有曲目」和「重複播放單一曲目」。

以任意順序播放 (隨機播放)

- 1 用方向按鈕選擇「播放模式」後，按 × 按鈕執行。

- 2 用方向按鈕選擇「隨機」後，按 × 按鈕設定。
- 3 按 ○ 按鈕，回到「瀏覽器」介面。
- 4 選擇音樂 CD 圖標後按 × 按鈕。
各曲目以任意順序顯示於畫面上。選擇您想要播放的曲目號碼後按 × 按鈕。開始播放。

重複執行隨機播放

按照上述 1 至 3 的步驟，然後參照重複播放所有曲目或單一曲目的說明進行操作。詳細內容請參閱本頁的「重複播放所有曲目」和「重複播放單一曲目」。

重複播放所有曲目

- 1 用方向按鈕選擇「重複」後，按 × 按鈕執行。
- 2 用方向按鈕選擇「全曲」後，按 × 按鈕設定。
- 3 按 ○ 按鈕，回到「瀏覽器」介面。
- 4 選擇音樂 CD 圖標後按 × 按鈕。
各曲目顯示於畫面上。選擇您想要播放的曲目號碼後按 × 按鈕。開始播放。

重複播放想要播放的曲目或重複以任意順序播放

按照上述 1 至 3 的步驟，然後參照以指定或任意順序播放想要播放的曲目的說明進行操作。詳細內容請參閱本頁的「自己編排播放順序」和「以任意順序播放」。

重複播放單一曲目

- 1 用方向按鈕選擇「重複」後，按 × 按鈕執行。
- 2 用方向按鈕選擇「單曲」後，按 × 按鈕設定。
- 3 按 ○ 按鈕，回到「瀏覽器」介面。
- 4 選擇音樂 CD 圖標後按 × 按鈕。
曲目顯示於畫面上。選擇您想要播放的曲目號碼後按 × 按鈕。開始播放。

重複播放想要播放的曲目或重複以任意順序播放

按照上述 1 至 3 的步驟，然後參照以指定或任意順序播放想要播放的曲目的說明進行操作。詳細內容請參閱本頁的「自己編排播放順序」和「以任意順序播放」。

您可通過顯示曲目號碼的畫面進入播放選項畫面。

用方向按鈕之上按鈕或左按鈕選擇畫面左上方的音樂 CD 小圖標，然後按 △ 按鈕。

出現播放選項畫面，您可按本頁的「各種播放模式」操作 CD 播放裝置。

在 CD 操作畫面按 ○ 按鈕後會顯示出曲目。選擇您想要播放的曲目，然後按 × 按鈕。開始播放。

播放 DTS 音軌的音樂 CD 時的注意事項

- 在播放以 DTS 格式錄製的音樂 CD 時，與 AV 多重輸出端子連接的音響裝置之類比聲音輸出口會發出極大的噪音。如果音響裝置的類比聲音輸出口是與接收器 (放大機) 連接的話，請注意防止音響系統受到損壞。在播放 DTS 音軌時，您必須將 DTS 解碼器連接至 DIGITAL OUT (OPTICAL) (數碼輸出光纖) 端子。
- 在「系統設定」選單將「DIGITAL OUT (OPTICAL)」設定為「關」時，即使通過光纖數碼連接線連接音響設備，您也無法從音樂 CD 收聽到 DTS 音效。



播放 DVD

某些 DVD 會因為製作上的限制，出現操作異常或無法操作的問題。詳細請參閱光碟的使用說明。

1 按主機背面的 MAIN POWER (主電源) 按鈕，接通電源。

當主機前面的 (預備) 顯示燈亮紅燈時，表示本機目前處於預備狀態。

2 按 (預備) / RESET (再啟動) 按鈕。

(預備) 顯示燈亮綠燈，螢幕上出現啟動畫面。

3 按 (打開) 按鈕。

打開光碟托盤。

4 使標籤之面朝上 (播放之面朝下)，將光碟放入托盤。

5 按 (打開) 按鈕。

關閉托盤，開始播放。

注意事項

- PlayStation®2 主機具備多種先進播放功能，使影音質量更趨完美。選用這些功能時需先調整設定，詳細內容請參閱第 20-26 頁。
- 在播放後按 按鈕，螢幕上會顯示「瀏覽器」介面。
- 播放 DVD 光碟時，請勿將主機連接在錄影機上，否則可能導致畫質下降。請將主機直接連接至電視機。

結束播放 DVD

看完 DVD 後，請按下列步驟保存 DVD 播放裝置的設定，或者返回瀏覽器畫面或讓主機進入預備狀態。

1 按 (打開) 按鈕。

光碟托盤打開後，出現瀏覽器畫面。

2 取出光碟。

3 按 按鈕關閉光碟托盤。

4 按住 / RESET (再啟動) 按鈕持續 3 秒鐘以上。

顯示燈變成紅燈，主機進入預備狀態。

注意事項

要保存變更後的 DVD 播放裝置的設定，您必須先退出 DVD，然後再按 (預備) / RESET (再啟動) 按鈕或主機背面的 MAIN POWER (主電源) 按鈕關閉電源。

如果您在播放 DVD 時遭遇到問題：

因為生產過程上的問題或加密技術而發生在 PlayStation®2 主機上無法正常操作情形是非常罕見的。假如您遭遇到這類問題，請先嘗試重新播放。如果問題仍然無法解決，請詢問 DVD 的發售廠商尋求更多相關資訊或聯絡保證書上記載的消費者服務中心。

操作 DVD 播放裝置

操作 DVD 播放裝置的方法有三種：

- 您可直接使用類比控制器 (DUALSHOCK®2) 按照以下說明操作 DVD 播放裝置。
- 您可通過畫面上的控制介面操作 DVD 播放裝置。從控制介面可以進入 DVD 播放裝置的另外一些選項及設定畫面。詳細內容請參閱第 15 頁的「使用控制介面」。

L2 按鈕： (快退尋找)
(第 19 頁)

L1 按鈕： (後退)

方向按鈕：控制游標

L3 按鈕*： (字幕選項)
(第 18 頁)

SELECT (選擇) 按鈕*：
顯示控制介面 (第 15 頁)

R2 按鈕： (快進尋找)
(第 19 頁)

R1 按鈕： (前進)

△ 按鈕： (選單)
(第 19 頁)

○ 按鈕：解除 / ■ (停止)

× 按鈕：決定

□ 按鈕： (頂部選單)
(第 16 頁)

R3 按鈕*： (聲音選項)
(第 18 頁)

START (開始) 按鈕：
▶ (播放) / || (暫停)

* 如果您使用沒有 L3、R3 按鈕的控制器，請開啓控制介面後 (參考第 15 頁的說明) 選擇 (字幕選項) 或 (聲音選項)。

機能

操作按鈕

停止

按 ○ 按鈕

暫停

按 START (開始) 按鈕

暫停後恢復播放

按 START (開始) 按鈕

進到下一個章的開頭

按 R1 按鈕

倒回播放中章的開頭或上一個章的開頭

按 L1 按鈕

- 您還能使用 PlayStation®2 專用 DVD 遙控器 (選購品) 操作 DVD 播放裝置。

使用類比控制器 (DUALSHOCK®2)

類比控制器 (DUALSHOCK®2) 各按鈕的功能如下所示。

注意

顯示出控制介面時，您無法使用類比控制器 (DUALSHOCK®2) 的直接按鈕功能。

使用控制介面

利用畫面上的控制介面，您可選擇各種播放模式，還能調整 DVD 播放裝置的各項設定。

請使用如下所示的類比控制器 (DUALSHOCK®2) 操作控制介面。



顯示或關閉控制介面：SELECT (選擇) 按鈕

決定：X 按鈕

解除：O 按鈕

選擇：方向按鈕之上下左右按鈕

1 按 SELECT (選擇) 按鈕。

螢幕上顯示控制介面。

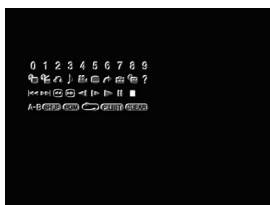

2 用方向按鈕選擇功能。

3 按 X 按鈕。

關於各項播放功能的詳細說明，請參考第 16 - 24 頁的說明。

控制介面項目一覽表



1 選單 (第 16 頁)

顯示 DVD 的光碟選單。選單內容因光碟而異。

2 頂部選單 (第 16 頁)

顯示 DVD 的光碟選單。選單內容因光碟而異。

3 Return (返回) (第 16 頁)

您可返回選單的前一個畫面。

4 聲音選項 (第 18 頁)

顯示或變更 DVD 聲音選項。

5 角度選項 (第 18 頁)

顯示或變更 DVD 觀看角度。

6 字幕選項 (第 18 頁)

顯示或變更 DVD 字幕選項。

7 進入 (第 18 頁)

進入指定的標題號碼、章號碼或時間，然後開始播放。

8 設定 (第 19 頁)

顯示變更各種圖像和聲音選項的設定顯示。您還可選擇字幕語言和選單語言、設定視聽年齡限制等級等。

9 時間顯示 (第 19 頁)

顯示目前的標題號碼、章號碼、已經播放時間以及剩餘播放時間。

10 ? 說明 (第 19 頁)

顯示類比控制器 (DUALSHOCK®2) 的按鈕功能。

11 進入章 (第 19 頁) / 號碼圖標 (第 19 頁)

您可選擇想要進入的章號碼。

12 後退

倒回播放中章的開頭或上一個章的開頭。

13 前進

進到播放中的下一個章的開頭。

14 尋找 (第 19 頁)

朝相反方向快速播放畫面以幫助尋找某個特定場面。

15 尋找 (第 19 頁)

朝播放方向快速播放畫面以幫助尋找某個特定場面。

16 慢放 (第 19 頁)

朝相反方向進行慢動作播放。

17 慢放 (第 19 頁)

朝播放方向進行慢動作播放。

18 播放

開始播放。

19 暫停

暫停或恢復播放。

20 停止

停止播放。

21 A-B A-B 重複播放 (第 17 頁)

播放已設定要重複播放的某個場面。

22 SHUP 隨機播放 (第 17 頁)

任意播放標題或章。

23 PGM 編序播放 (第 16 頁)

顯示編序設定畫面。

24 重複播放 (第 17 頁)

重複播放光碟的所有標題、或某個標題或章。

25 PLIST 原作品 / 播放目錄 (第 18 頁)

播放以 VR 模式錄製的 DVD-RW 光碟。選擇原作品或播放目錄內容進行播放。

26 CLEAR 解除

取消已選擇的數字或播放模式。

您可利用控制介面設定各種播放模式。

使用 DVD 光碟選單

您可開啓選單選擇某些 DVD 的光碟收錄內容。在播放這類 DVD 時，您可利用選單指定播放項目、字幕語言、聲音語言以及其他選項。

1 用方向按鈕選擇 (選單) 或 (頂部選單)，按 × 按鈕決定。

螢幕上顯示 DVD 選單，但選單內容可能因 DVD 而異。

2 用方向按鈕選擇您想要的項目後按 × 按鈕。

返回到前一個畫面

用方向按鈕選擇  (返回) 後，按 × 按鈕執行。

某些 DVD 可能不支援這項功能。

使用類比控制器 (DUALSHOCK®2)

1 按 △ 或 □ 按鈕。

螢幕上顯示 DVD 選單，但選單內容可能因 DVD 而異。

2 用方向按鈕選擇您想要的項目後按 × 按鈕。

注意事項

- 某些 DVD 可能本身不具備選單。
- 部分 DVD 可能會將「選單」稱為「DVD 選單」、「標題選單」或「標題」。

確認播放設定

播放時，用方向按鈕選擇  (時間顯示) 圖標，然後按 × 按鈕。目前設定的播放方式的圖標即會顯示於螢幕右上方。

解除所有的播放設定，返回正常播放

用方向按鈕選擇 **CLEAR** (解除) 圖標後，按 × 按鈕。

從停播點恢復播放 (重續播放)

當播放停止時，本機將記錄光碟的停播位置，您可選擇從此點恢復播放。

1 播放時，按 ○ 按鈕停止播放。

電視機螢幕會出現「選擇 [播放] 將會從停播點起繼續播。要從頭開始播放時，請選擇 [停止] 後再選擇 [播放]。」的字樣，並顯示控制介面。假如出現「禁止使用重續播放功能，下次選擇播放時，將從頭開始播放。」的字樣，則代表不能使用重續播放。

2 用方向按鈕之左右按鈕，選擇 (播放) 後，按 × 按鈕執行。

本機從步驟 1 的停播點起繼續播放。



取消停播點

在步驟 1 後選擇  (停止) 圖標，按 × 按鈕。

解除重續播放

如果停播後恢復播放，DVD 播放裝置就進入重續播放模式。在選擇重續播放時您無法使用 DVD 播放裝置的許多專業設定。若要取消重續播放以調整各項設定，請選擇  (停止) 圖標後連按兩次 × 按鈕。

注意事項

- 某些 DVD 可能不支援重續播放功能。
- 由於停止設定上的問題，實際繼續播放的位置可能會與停播點有所不同。
- 出現下列情形時，將自動解除重續播放。
 - 設定編序播放或隨機播放時。
 - 按  (打開) 按鈕，打開光碟托盤。
 - 按  /RESET (再啓動) 按鈕，令主機回到預備狀態。
 - 按主機背面的 MAIN POWER (主電源) 按鈕，關閉電源。
 - 在播放途中選擇  (停止) 圖標後連按兩次 × 按鈕。

自己編排播放順序 (編序播放)

您可依自己喜好編排標題及章的播放順序。

1 用方向按鈕選擇 (編序播放) 圖標後，按 × 按鈕。

2 用方向按鈕選擇項目號碼後，按 × 按鈕。

3 用方向按鈕選擇標題號碼後，按 × 按鈕。

4 用方向按鈕選擇章號碼後，按 × 按鈕。

5 反覆步驟 2-4，選擇其他要播放的標題或章。

6 按 START (開始) 按鈕。

開始編序播放。

即使編序播放已經結束，您設定的播放順序依舊存在。使用方向按鈕選擇  (編序播放) 圖標後，按 × 按鈕。開啓編序設定畫面後，再按 START (開始) 按鈕，即可再次進行相同的編序播放。

改變或取消編序播放設定

1 用方向按鈕選擇 (編序播放) 圖標後，按 × 按鈕。

2 用方向按鈕選擇想要變更的項目號碼後，按 × 按鈕。

3 用方向按鈕選擇想要播放的標題號碼後，按 × 按鈕。

4 用方向按鈕選擇想要播放的章號碼後，按 × 按鈕。



若要取消編序播放設定，請在步驟 3 選擇「消除」後，按 × 按鈕。

取消所有的編序播放設定

1 用方向按鈕選擇 (編序播放) 圖標後，按 × 按鈕。



2 用方向按鈕選擇「全部消除」後，按 × 按鈕。

使用編序播放時進行隨機播放或重複播放

- 編序播放搭配隨機播放
在執行編序播放時，使用方向按鈕選擇  (隨機播放) 圖標後，按 × 按鈕即可開始隨機播放。當設定編序播放後使用隨機播放時，您只能選擇「使用隨機播放」或「解除隨機播放」等隨機播放選項。
- 編序播放搭配重複播放
在執行編序播放時，使用方向按鈕選擇  (重複播放) 圖標後，按 × 按鈕即可開始重複播放。當設定編序播放後使用重複播放時，您只能選擇「使用重複播放」或「解除重複播放」等重複播放選項。

關於隨機播放和重複播放的詳細內容，請參閱第 17 頁「以任意順序播放 (隨機播放)」及「反覆持續播放 (重複播放)」的說明。

注意事項

- 在選擇編序播放進行播放時，您無法變更編序播放的各項設定。
- 設定編序播放後，將自動解除 A-B 重複播放。
- 某些 DVD 可能不支援編序播放功能。
- 畫面上僅會顯示被錄製於光碟中的標題號碼與章號碼。
- 出現下列情形時，將自動停止編序播放：
 - 設定 A-B 重複播放。
 - 螢幕上顯示 DVD 光碟選單。
- 出現下列情形時，將自動解除編序播放：
 - 按主機前面的  (打開) 按鈕，打開光碟托盤。
 - 按  /RESET (再啓動) 按鈕，令主機回到預備狀態。
 - 按主機背面的 MAIN POWER (主電源) 按鈕，關閉電源。

以任意順序播放（隨機播放）

主機會自動依任意設定的隨機順序進行播放。使用隨機播放時，每次的播放順序都會不同。

在播放過程中用方向按鈕選擇 **SHUF**（隨機播放）圖標後，按 **×** 按鈕。

每按一次 **×** 按鈕，都會依以下順序，於螢幕上顯示隨機播放模式。於選擇隨機播放模式後，即會開始隨機播放。

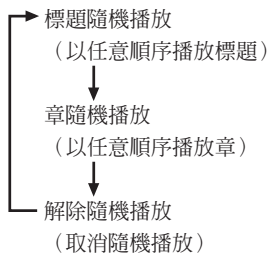

結束隨機播放

用方向按鈕選擇 **SHUF**（隨機播放）圖標，然後按 **×** 按鈕直至顯示「解除隨機播放」。

使用隨機播放時進行編序播放或重複播放

• 隨機播放搭配編序播放

在執行隨機播放時，使用方向按鈕選擇 **PGM**（編序播放）圖標後，按 **×** 按鈕。並於設定自己想要的播放順序後，按下 **START**（開始）按鈕，即可開始隨機播放。當設定編序播放後使用隨機播放時，您只能選擇「使用隨機播放」或「解除隨機播放」等隨機播放選項。

• 隨機播放搭配重複播放

在執行隨機播放時，使用方向按鈕選擇 **REP**（重複播放）圖標後，按 **×** 按鈕，即可開始重複播放。當設定隨機播放後使用重複播放時，您只能選擇「使用重複播放」或「解除重複播放」等重複播放選項。

關於編序播放和重複播放的詳細內容，請參閱第 16 頁「自己編排播放順序（編序播放）」及第 17 頁的「反覆持續播放（重複播放）」的說明。

在停止播放時設定隨機播放

使用方向按鈕選擇 **SHUF**（隨機播放）圖標後，按 **×** 按鈕選擇想要的隨機播放模式後，再使用方向按鈕選擇 **▶**（播放）圖標後，按 **×** 按鈕，即會開始隨機播放。

注意事項

- 開始隨機播放後，將自動解除 A-B 重複播放。
- 某些 DVD 可能不支援隨機播放功能。
- 出現下列情形時，將自動解除隨機播放。
 - 設定 A-B 重複播放。
 - 螢幕上顯示 DVD 光碟選單。
 - 按主機前面的 **△**（打開）按鈕，打開光碟托盤。
 - 按 **○**/RESET（再啟動）按鈕，令主機回到預備狀態。
 - 按主機背面的 MAIN POWER（主電源）按鈕，關閉電源。
- 選擇章隨機播放時，最多可隨機播放被記錄在光碟中的 200 個章。假如光碟中收錄了 200 個以上的章，那麼主機將隨機選擇 200 章。

反覆持續播放（重複播放）

使用重複播放，可重複播放 DVD 的所有標題或某個標題、章。

播放時用方向按鈕選擇 **REP**（重複播放）圖標後，按 **×** 按鈕。

每按一次 **×** 按鈕，都會依以下順序，於螢幕上顯示重複播放模式。於選擇重複播放模式後，即會開始重複播放。

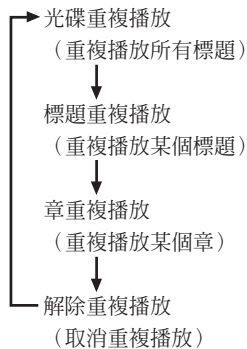

結束重複播放

用方向按鈕選擇 **REP**（重複播放）圖標，然後按 **×** 按鈕直至顯示出「解除重複播放」。

使用重複播放時進行編序播放或隨機播放

• 重複播放搭配編序播放

在執行重複播放時，使用方向按鈕選擇 **PGM**（編序播放）圖標後，按 **×** 按鈕。並於設定自己想要的播放順序後，按下 **START**（開始）按鈕，即可開始重複播放。當設定編序播放後使用重複播放時，您只能選擇「使用重複播放」或「解除重複播放」等重複播放選項。

• 重複播放搭配隨機播放

在執行重複播放時，使用方向按鈕選擇 **SHUF**（隨機播放）圖標後，按 **×** 按鈕，即可開始重複播放。當設定隨機播放後使用重複播放時，您只能選擇「使用重複播放」或「解除重複播放」等重複播放選項。

關於編序播放和隨機播放的詳細內容，請參閱第 16 頁「自己編排播放順序（編序播放）」及第 17 頁「以任意順序播放（隨機播放）」的說明。

在停止播放時設定重複播放

使用方向按鈕選擇 **REP**（重複播放）圖標後，按 **×** 按鈕選擇想要的重複播放模式後，再使用方向按鈕選擇 **▶**（播放）圖標後，按 **×** 按鈕，即會開始隨機播放。

注意事項

- 開始重複播放後，將自動解除 A-B 重複播放。
- 某些 DVD 可能不支援重複播放功能。
- 出現下列情形時，將自動解除重複播放。
 - 設定 A-B 重複播放。
 - 按主機前面的 **△**（打開）按鈕，打開光碟托盤。
 - 按 **○**/RESET（再啟動）按鈕，令主機回到預備狀態。
 - 按主機背面的 MAIN POWER（主電源）按鈕，關閉電源。

重複播放指定部分（A-B 重複播放）

反覆不斷播放光碟的指定部分。

1 播放時，使用方向按鈕選擇 **A-B**（A-B 重複播放）圖標後，設定要重複播放部分的起點，按 **×** 按鈕。

完成起點的設定。

2 播放時，使用方向按鈕選擇 **A-B**（A-B 重複播放）圖標後，設定要重複播放部分的終點，按 **×** 按鈕。

完成終點的設定。開始 A-B 之間的重複播放。

注意事項

- 某些 DVD 可能不支援 A-B 重複播放功能。
- 只能設定一個 A-B 重複播放。
- 只能指定一個標題中的某一部分，進行 A-B 重複播放。
- 出現下列情形時，將自動解除 A-B 重複播放。
 - 設定編序播放、隨機播放、或重複播放。
 - 停止播放。
 - 螢幕上顯示 DVD 光碟選單。
 - 按主機前面的 **△**（打開）按鈕，打開光碟托盤。
 - 按 **○**/RESET（再啟動）按鈕，令主機回到預備狀態。
 - 按主機背面的 MAIN POWER（主電源）按鈕，關閉電源。
- 設定 A-B 重複播放後，將自動解除編序播放、隨機播放以及重複播放。

播放 DVD-RW 時選擇原作品／播放目錄

本機可以播放 DVD-RW (VR 模式) 中，用 DVD 播放機錄製的原創作品內容，並能播放在編輯原創作品內容後而製造的播放目錄內容。當使用此類光碟時，您可事先選擇想要播放的標題類型。請注意，您無法利用本機錄製或編輯播放內容。另外，在選擇重續播放時，將無法使用或設定本功能。

停止播放後，用方向按鈕選擇 **PLIST** (原作品／播放目錄) 圖標後，按 **×** 按鈕。

每按一次 **×** 按鈕，都將切換選擇原作品或播放目錄。

- 原作品：播放原先錄製的內容。
- 播放目錄：播放經編輯的內容。

注意事項

- 此選項的初期設定為播放目錄。
- 如果光碟未錄製播放目錄，則將播放原作品內容。您無法選擇播放目錄。
- 以 VR 模式錄製的 DVD-RW 光碟，您無法選擇相反方向的慢動作播放。
- 出現下列情形時，將自動解除「原作品」設定。
 - 按主機前面的 **△** (打開) 按鈕，打開光碟托盤。
 - 按 **○**/RESET (再啟動) 按鈕，令主機回到預備狀態。
 - 按主機背面的 MAIN POWER (主電源) 按鈕，關閉電源。
- 以 VR 模式錄製在 DVD-RW 光碟上的內容必須經過最終化操作才能在 PlayStation®2 主機上觀看。

您可利用控制介面操作 DVD，或調整 DVD 播放裝置的各項設定。

請注意，並不是所有的功能都適用於所有的 DVD 光碟。

更改聲音語言

在播放一張錄製多重語言 (多重軌跡) 的 DVD 時，您可在播放時選擇要聽的語言。可選擇的聲音語言因 DVD 而異。

用方向按鈕選擇 **♪** (聲音選項) 圖標後，按 **×** 按鈕。

每按一次 **×** 按鈕都會更改一次播放語言。

使用類比控制器 (DUALSHOCK®2)

按 R3 按鈕。

每按一次 R3 按鈕都會更改一次播放語言。

注意事項

- 某些錄製了多種語言的 DVD 會因為程式燒錄上的問題，而可能出現無法更改播放語言的情形。
- 播放中改變標題的行為，可能強制改變語言的播放設定。
- 在設定畫面的「聲音設定」中，將「Audio Digital Out」的 DTS 選項設定為「關」時，即使播放錄有 DTS 音軌的 DVD，您也無法選擇 DTS 進行播放。

更改觀看角度

插入一張錄製多種角度 (多角度) 的 DVD 時，您可在播放時更改取景的角度。例如，當您播放列車行走的場景時，您可選擇從列車的前頭、左側窗戶、右側窗戶觀賞一路的風景但不需要中斷列車的行走。

用方向按鈕選擇 **👤** (角度選項)，按 **×** 按鈕決定。

每按一次 **×** 按鈕，都會更改一次角度。

注意事項

- 角度的多少，會因為光碟和場景而有所不同。您只能選擇被收錄在該場景下的角度，做不同感覺的觀賞。
- 某些錄製了多種角度的 DVD，會因為程式燒錄上的問題，而可能出現無法更改角度的情形。

顯示字幕

插入一張附有字幕的 DVD，您可在播放時要求顯示或隱藏字幕。使用多種字幕的 DVD 時，則可在播放時選擇所要的字幕。

用方向按鈕選擇 **☰** (字幕選項)，按 **×** 按鈕決定。

您可按鈕不斷改變字幕語言，並要求顯示或隱藏字幕。可選擇的字幕種類會因為 DVD 而有所不同。

隱藏字幕

用方向按鈕選擇 **☰** (字幕選項) 圖標，然後按 **×** 按鈕直至顯示「字幕 關」。

使用類比控制器 (DUALSHOCK®2)

按 L3 按鈕。

每按一次 R3 按鈕都會不斷改變字幕語言，並能要求顯示或隱藏字幕。可選擇的字幕種類會因為 DVD 而有所不同。

隱藏字幕

按 L3 按鈕直至顯示「字幕 關」。

注意事項

- 假如您選擇的 DVD 並未收錄字幕，那麼就不會顯示字幕。
- 某些附有字幕的 DVD 會因為程式燒錄上的問題，而可能出現無法顯示字幕、改變字幕，或是隱藏字幕的情形。
- 部分 DVD 禁止隱藏字幕。
- 字幕的可記錄種類及可記錄數量，會因為 DVD 而有所不同。
- 播放中改變標題的行為，可能強制改變字幕的播放設定。

選擇播放一個特定場面

您可指定標題或章的號碼，或者輸入想要播放的起始點的已經播放時間來選擇播放某個特定場面。

利用章號碼選擇場面

播放時，用方向按鈕選擇想要的章號碼後，按 **×** 按鈕。

開始播放所選擇的章。

通過標題號碼、章號碼或指定時間來選擇場面

1 播放時，用方向按鈕選擇 **↶** (進入) 圖標後，按 **×** 按鈕。

2 用方向按鈕選擇需要的項目後，按 **×** 按鈕。

- 標題 = 標題號碼
- 章 = 章號碼
- C XX:XX:XX (或 T XX:XX:XX)
= 章 (或標題) 的已經播放時間

3 用方向按鈕選擇播放點後，按 **×** 按鈕。

開始播放所選擇的場景。

注意事項

您無法指定章或標題的剩餘播放時間來選擇場面。(您只能指定已經播放時間。)

顯示播放資訊

您可隨時要求螢幕上顯示目前的標題號碼或章號碼，以及光碟的已經播放時間或剩餘播放時間。編序播放或隨機播放等播放模式的資訊，亦會於您選擇設定後，顯示於螢幕右上方。

播放光碟或暫停播放時，用方向按鈕選擇 (時間顯示) 圖標後，按 **×** 按鈕。
每按一次 **×** 按鈕，顯示內容都將如下改變。

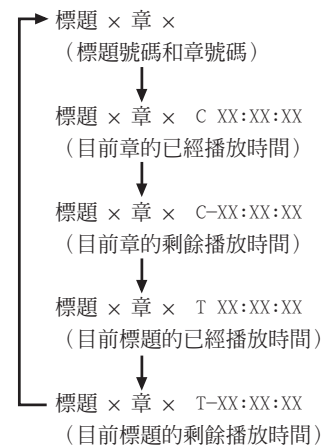

注意事項

您可能無法要求顯示某些標題的剩餘播放時間。

顯示按鈕功能一覽表 (說明)

您可開啓標有類比控制器 (DUALSHOCK®2) 各按鈕功能的一覽表。

用方向按鈕選擇 ? (說明) 圖標後，按 **×** 按鈕。即會顯示各按鈕功能的一覽表。

您可按 **×** 按鈕，選擇顯示或隱藏該畫面。

發現光碟的特殊場景 (尋找)

利用尋找功能可以快速尋找 DVD 的特殊場景。您可透過前進尋找或後退尋找，運用三種尋找速度與慢動作播放等播放速度，掃描影像特定場景。於關閉控制介面後，則可利用類比控制器 (DUALSHOCK®2) 使用這項功能。

- 1 播放時，用方向按鈕選擇 (尋找、快退) 或 (尋找、快進) 圖標後，按 **×** 按鈕開始尋找。在尋找時，按方向按鈕可以改變影像的掃描速度。

按住 **×** 按鈕的同時按方向按鈕，影像的掃描速度都將如下改變：

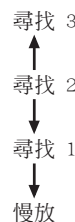

- 2 發現想要播放的場景後，放開 **×** 按鈕。

恢復正常播放速度。

使用類比控制器 (DUALSHOCK®2)

- 1 播放時，按住 L2 或 R2 按鈕開始尋找。在尋找時，按方向按鈕可以改變影像的掃描速度。

按住 L2 或 R2 按鈕的同時按方向按鈕，影像的掃描速度都將如下改變：

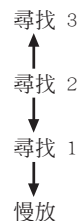

- 2 發現想要播放的場景後，放開 L2 或 R2 按鈕。

恢復正常播放速度。

注意事項

某些 DVD 禁止本項操作。

慢動作播放

播放時，用方向按鈕選擇 ◀ (相反方向慢放) 或 ▶ (播放方向慢放) 圖標後，按 **×** 按鈕。開始慢動作播放。

結束慢動作播放

用方向按鈕選擇 ▶ (播放) 圖標後，按 **×** 按鈕。恢復正常播放速度。

使用設定顯示選單

使用設定顯示選單，您可選擇恢復初期設定、調節畫質和聲音，並設定各種輸出端子等。您還可選擇字幕語言和選單語言、設定視聽年齡限制等級等。關於設定顯示的詳細內容，請參閱第 20-24 頁。

使用設定顯示選單前

在選擇重續播放時，可能將無法開啓某些選單。詳細將會於以後的介紹中仔細說明。至於重續播放模式的解除方法，請參閱第 16 頁的「解除重續播放」。

- 1 用方向按鈕選擇 (設定) 圖標後，按 **×** 按鈕。

顯示各種設定圖標，選擇這些圖標，進入下頁所示的各選單。

- 2 用方向按鈕選擇想要改變設定的圖標後，按 **×** 按鈕。

顯示所選圖標的選單。

- 3 用方向按鈕選擇需要的選單項目後，按 **×** 按鈕。

顯示所選的選單項目之各選項。

- 4 用方向按鈕指定一個選項後，按 **×** 按鈕。

完成指定選項的設定。

使用設定顯示選單後

若要保存播放時改變的設定，您必須先停止播放*或退出 DVD，然後再按主機前面的 (預備) / RESET (再啟動) 按鈕，或按主機背面的 MAIN POWER (主電源) 按鈕關閉電源。請注意，若是在退出光碟前，即再度啟動主機或關閉主機電源的話，則無法保存變更後的設定內容。

* 包括在重續播放過程中停止播放。

設定顯示選單

設定顯示選單的構成如下所示。購買時的初期設定標有下線。

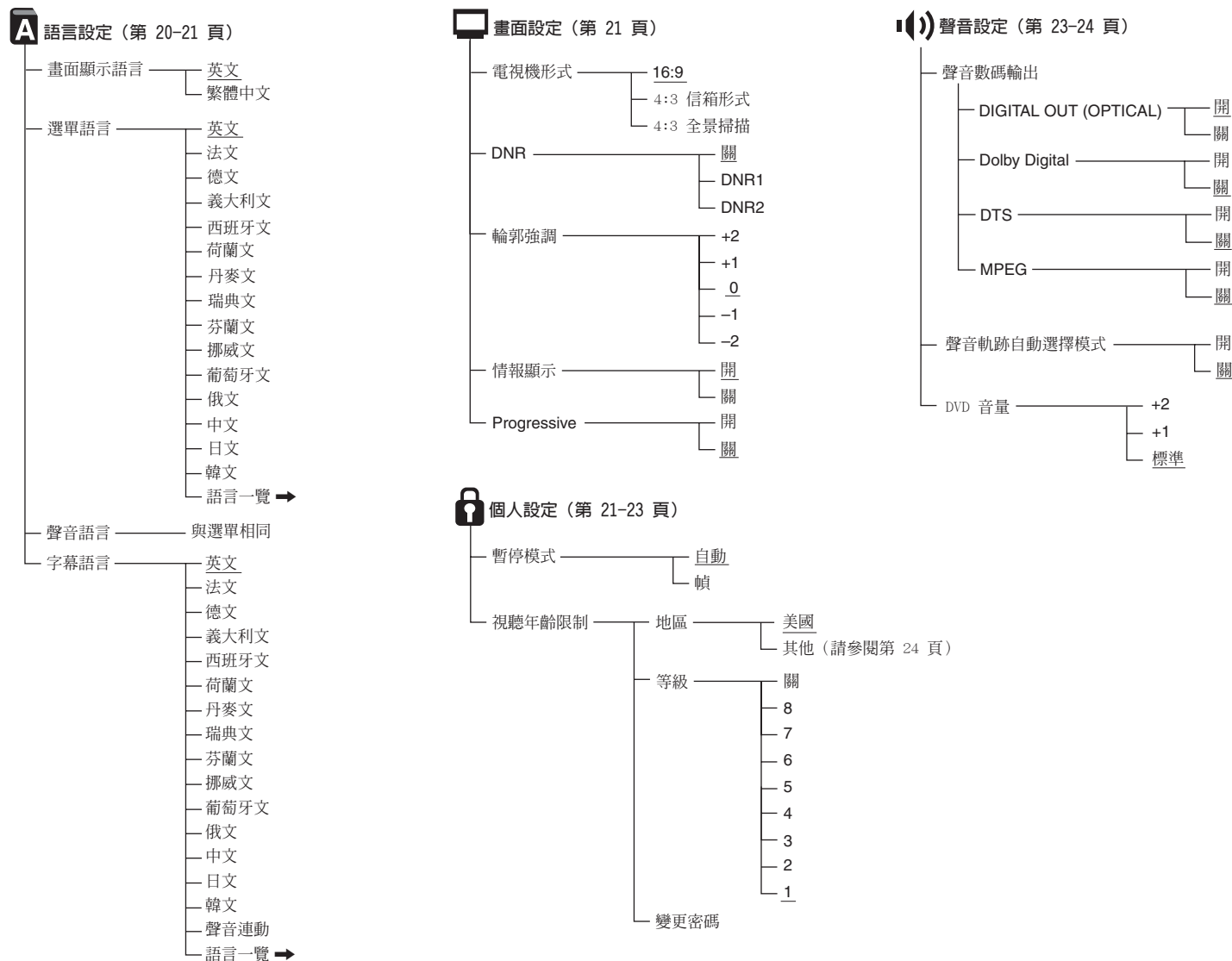

設定使用語言 (語言設定)

在「語言設定」裡，您可從各種語言中選擇畫面顯示語言、DVD 聲音語言等。購買時的初期設定標有下線。

必須選擇設定顯示選單中的 **A** (語言設定) 圖標後才能開始設定。詳細內容請參閱第 19 頁的「使用設定顯示選單」。

注意事項

- 如果您選擇了一種光碟中並未記錄的語言，那麼本機會自動替「選單」、「聲音」、「字幕」選擇一種記錄語言。
- 本機可能會因 DVD 的關係而無法在「選單」、「聲音」、「字幕」上顯示您所選擇的語言。

■ 畫面顯示語言

選擇畫面的顯示語言。

- 英文
- 繁體中文

■ 選單語言

選擇 DVD 光碟選單的語言。

在選擇重續播放時，將無法使用或設定本功能。

- 英文
- 法文
- 德文
- 義大利文
- 西班牙文
- 荷蘭文
- 丹麥文
- 瑞典文
- 芬蘭文
- 挪威文
- 葡萄牙文
- 俄文
- 中文
- 日文
- 韓文
- 語言一覽*

* 選擇「語言一覽」時，可從語言一覽表中，選擇語言。

■ Audio (聲音語言)

選擇聲音軌跡語言。

在選擇重續播放時，將無法使用或設定本功能。

- 英文
- 法文
- 德文
- 義大利文
- 西班牙文
- 荷蘭文
- 丹麥文
- 瑞典文
- 芬蘭文
- 挪威文
- 葡萄牙文
- 俄文
- 中文
- 日文
- 韓文
- 語言一覽*

* 選擇「語言一覽」時，可從語言一覽表中，選擇語言。

■ 字幕語言

選擇字幕語言。

在選擇重續播放時，將無法使用或設定本功能。

- 英文
- 法文
- 德文
- 義大利文
- 西班牙文
- 荷蘭文
- 丹麥文
- 瑞典文
- 芬蘭文
- 挪威文
- 葡萄牙文
- 俄文
- 中文
- 日文
- 韓文
- 聲音連動*1
- 語言一覽*2

*1 選擇「聲音連動」後，則字幕會隨著所選擇的聲音語言而變化。

*2 選擇「語言一覽」時，可從語言一覽表中，選擇語言。

設定電視機的螢幕 (畫面設定)

您可設定所連接的電視機的縱橫比及其它顯示選項。購買時的初期設定標有下線。

從設定顯示選單中選擇  (畫面設定) 圖標。詳細內容請參閱第 19 頁的「使用設定顯示選單」。

■ 電視機形式

設定您所連接的電視機形式。

在選擇重續播放時，將無法使用或設定本功能。

- 16:9：當您連接一台寬螢幕電視或具備寬螢幕模式的普通電視機時的標準設定。
- 4:3 信箱形式：使用普通電視機時的標準設定。顯示寬螢幕影像時，畫面上下將會出現黑邊。
- 4:3 全景掃描：使用普通電視機時，寬螢幕規格的影像會自動顯示在整個螢幕上，但左右兩邊超出螢幕部分會被切除。

16:9

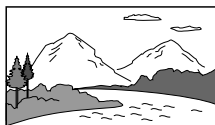

4:3 信箱形式



4:3 全景掃描

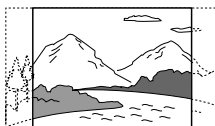

注意事項

- 某些 DVD 會自動以預先設定之電視機縱橫比展開播放。
- 若將「Progressive」設定為「開」，則電視機的縱橫比會被自動設定為「16:9」，且無法擅自變更。

■ DNR (Digital Noise Reduction)

此設定有助於減小畫面上影像的粗糙程度，提供更為清晰的圖像。

- 關：通常的標準設定。
- DNR1：增強影像的清晰度。
- DNR2：增強影像的清晰度。（最高清晰度）

注意事項

- DNR2 比 DNR1 更有效地減小圖像顆粒的粗糙程度，但有時可能出現殘像。如果出現這種情況，請選擇「關」。
- DNR 會由於 DVD 的緣故而出現難以發揮功能的現象。
- 將「Progressive」（逐行掃描）設定為「開」時，DNR 功能會自動關閉。

■ 輪廓強調

設定畫面輪廓的銳利柔和。數值愈高，代表輪廓愈鮮明銳利。

- +2
- +1
- 0：通常的標準設定。
- -1
- -2

■ 情報顯示

設定在螢幕上顯示或隱藏播放的狀況資訊。

- 開：播放 DVD 時，螢幕會數秒間顯示播放資訊。
- 關：不顯示播放資訊。

■ Progressive (逐行掃描)

這種顯示圖像的方式通過一次刷新就完成所有行的掃描，因此在大多數情況下能顯示比隔行方式時更穩定、更清晰而且無閃爍的圖像。

在選擇重續播放時，將無法使用或設定本功能。

- 開：連接支援逐行掃描的電視機時，選擇此項設定。
- 關：連接普通電視機時，選擇此項設定。

注意事項

- 要使用逐行掃描功能，您必須使用支援逐行掃描 (480p) 的電視機，並使用 PlayStation®2 專用影像色差連接線 SCPH-10100 G (選購品) 連接主機。
- 如果您沒有使用必要的設備而將「Progressive」（逐行掃描）設定為「開」時，可能會造成畫質下降或圖像消失。
- 如果您誤將此選項設定為「開」並需要解除改設定時，請

在 DVD 放入主機內的狀態下，按主機前面的 (預備) /RESET (再啟動) 按鈕，然後按住已插入控制器端子 1 的類比控制器 (DUALSHOCK®2) 的 START (開始) 按鈕，直至 DVD 畫面出現。當DVD開始播放時，「Progressive」（逐行掃描）的設定會變成「關」。DVD 畫面也會正常顯示。您也可通過版本畫面將「Progressive」（逐行掃描）設定為「關」。詳細內容請參閱第 9 頁。

- 如果播放的 DVD-RW 光碟內容是以VR模式錄製的，則無法使用逐行掃描功能。
- DVD 圖像可以包含幀速率不同的視頻來源的素材和電影來源的素材。當以逐行掃描播放電影來源的素材時，由於經過了圖像轉換過程，有些影像可能顯得不自然。出現這種情況時，請將「Progressive」（逐行掃描）設定為「關」後，選擇隔行方式觀看。

設定個人資訊 (個人設定)

利用個人設定，您可選擇視聽年齡限制等級並調整其它特殊功能。

購買時的初期設定標有下線。

從設定顯示選單中選擇  (個人設定) 圖標。詳細內容請參閱第 19 頁的「使用設定顯示選單」。

■ 暫停模式

設定暫停模式時的圖像狀態。

- 自動：可以無抖動地顯示出含有許多動態部分的圖像。通常的標準設定。
- 幀：能表現高解析度的靜止圖框影像，但無法確實表現動態移動。

■ 視聽年齡限制

根據各地區的視聽者年齡等因素，限制某些 DVD 的播放權限。您可利用視聽年齡限制功能來控制主機的視聽等級。

在選擇重續播放時，將無法使用或設定本功能。

設定視聽年齡限制

從設定顯示選單中選擇  (個人設定) 圖標。

1 用方向按鈕選擇「視聽年齡限制」後，按 × 按鈕。

如果尚未登錄密碼
顯示登錄密碼的畫面。

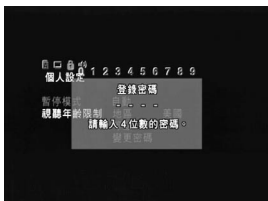

如果已經登錄了密碼
顯示確認密碼的畫面。



2 用方向按鈕選擇一個數字後，按 × 按鈕。

重複此過程，輸入一個四位數密碼。
出現設定地區、視聽年齡限制等級、以及改變密碼的畫面。



3 用方向按鈕選擇「地區」後，按 × 按鈕。

出現地區一覽表。



4 用方向按鈕選擇一個地區作為設定視聽年齡限制等級的標準後，按 × 按鈕。

選擇「其他」時，請參照右表的「地區代碼一覽表」來選擇地區代碼。
用方向按鈕選擇第一個字母後，按右方向按鈕。再按方向按鈕選擇第二個字母後，按 × 按鈕。



5 用方向按鈕選擇「等級」後，按 × 按鈕。

出現等級選項一覽。



6 用方向按鈕選擇一個限制播放的等級後，按 × 按鈕。

視聽年齡限制設定完成。
數值越小，代表等級越嚴格。



地區代碼一覽表

地區	代碼	地區	代碼
英國	GB	中國	CN
義大利	IT	丹麥	DK
印度尼西亞	ID	德國	DE
澳大利亞	AT	日本	JP
荷蘭	NL	挪威	NO
加拿大	CA	菲律賓	PH
韓國	KR	芬蘭	FI
新加坡	SG	法國	FR
瑞士	CH	比利時	BE
瑞典	SE	香港	HK
西班牙	ES	馬來西亞	MY
泰國	TH	俄羅斯	RU
臺灣	TW		

變更密碼

1 在「設定視聽年齡限制」的步驟 2 時用方向按鈕選擇「變更密碼」後，按 × 按鈕。
顯示變更密碼的畫面。

2 用方向按鈕選擇一個數字後，按 × 按鈕。

重複此過程，輸入一個四位數密碼。
為確認無誤，請再輸入一次該密碼。
密碼變更完畢。

播放受視聽年齡限制保護的光碟

1 放入光碟。

開始播放。當播放到受視聽年齡限制的位置時，畫面上會顯示出字句來確認是否要暫時變更視聽年齡限制的等級。

2 用方向按鈕選擇「是」後，按 × 按鈕。

顯示確認密碼的畫面。

3 用方向按鈕輸入數字後，按 × 按鈕。

重複此過程來輸入一個四位數密碼。
開始播放。
停止播放後，視聽年齡限制將會自動恢復為原始設定。

如果忘記了密碼

1 出現確認密碼的畫面時按 SELECT (選擇) 按鈕。

出現刪除密碼的畫面。

2 用方向按鈕選擇一個數字後，按 × 按鈕。

重複此過程來輸入四位數號碼

「7444」。如此，原先的舊密碼就會被自動刪除。並顯示登錄新密碼的畫面。

3 按照「設定視聽年齡限制」步驟 2 的方法登錄一個新密碼。

注意事項

- 選擇沒有視聽年齡限制的 DVD 時，不需要特地修改或刪除亦可正常播放。
- 假如您沒有設定密碼，那麼就無法變更視聽年齡限制的設定。
- 某些 DVD 可能因為 DVD 本身內容的緣故，在播放前強制要求您輸入密碼。
- 某些設定了視聽年齡限制的 DVD 可能無法進行編序播放、隨機播放，重複播放或 A-B 重複播放。

解除視聽年齡限制

停止播放 DVD 後，在「設定視聽年齡限制」的步驟 6 將「等級」設定為「關」。

在選擇重續播放時，將無法解除視聽年齡限制。

設定聲音選項 (聲音設定)

您可根據播放條件或使用的裝置調整聲音設定。購買時的初期設定標有下線。詳細內容請參閱第 19 頁的「使用設定顯示選單」。

從設定顯示選單中選擇  (聲音設定) 圖標。

■ 聲音數碼輸出

使用數碼輸出光纖連接線 (選購品) 將下列音響設備連接至 PlayStation®2 主機背面的 DIGITAL OUT (OPTICAL) (數碼輸出光纖) 端子時，您可改變音頻信號的輸出方式。

- 具備數碼輸出端子的數碼接收器 (擴大機)。
 - 內建 Dolby Digital、DTS 或 MPEG 解碼器的音響設備。
 - DAT (數碼音頻錄音帶) 或 MD (迷你光碟) 唱機。
- 關於連接的詳細內容，請參閱第 7 頁。

■ DIGITAL OUT (OPTICAL) (數碼輸出光纖)

選擇是否使用 DIGITAL OUT (OPTICAL) (數碼輸出光纖) 傳送聲音信號。

開啓「系統設定」後選擇的設定內容會自動反映到本項目。

- 開**：使用數碼輸出光纖連接線 (選購品) 傳送時。通常選擇此項設定。
當您選擇「開」時，可修改「Dolby Digital」(杜比數碼 AC-3)、「DTS」或「MPEG」的設定。
- 關**：不通過數碼輸出光纖端子傳送聲音信號時，選擇此項設定。

注意事項

選擇「關」時，您就無法修改「Dolby Digital」(杜比數碼 AC-3)、「DTS」或「MPEG」的設定。

■ Dolby Digital (杜比數碼 AC-3)

選擇使用 DIGITAL OUT (OPTICAL) (數碼輸出光纖) 端子傳送 Dolby Digital (杜比數碼 AC-3) 信號。

- 開**：當本機連接內建 Dolby Digital (杜比數碼 AC-3) 解碼器的音響設備上時選擇此項設定。
如果本機並未連接內建 Dolby Digital (杜比數碼 AC-3) 解碼器的音響設備，請勿將本選項設定 (開)。假如您選擇錯誤，在播放支援 Dolby Digital (杜比數碼 AC-3) 的光碟時，喇叭會發出刺耳的劇烈雜音 (或發不出聲音)，更可能會損壞到您的耳朵及喇叭。
- 關**：當本機連接的音響設備並未內建 Dolby Digital (杜比數碼 AC-3) 解碼器時選擇此項設定。

■ DTS

選擇使用 DIGITAL OUT (OPTICAL) (數碼輸出光纖) 端子傳送 DTS 信號。

在選擇重續播放時，將無法使用或設定本功能。

- 開**：當本機連接在內建 DTS 解碼器的音響設備上時選擇此項設定。
如果本機並未連接內建 DTS 解碼器的音響設備，請勿將本選項設定 (開)。假如您選擇錯誤，在播放支援「DTS」的光碟時，喇叭會發出刺耳的劇烈雜音 (或發不出聲音)，更可能會損壞到您的耳朵及喇叭。
- 關**：當本機連接的音響設備並未內建 DTS 解碼器時選擇此項設定。

■ MPEG

選擇使用 DIGITAL OUT (OPTICAL) (數碼輸出光纖) 傳送 MPEG 信號。

- 開**：當本機連接在支援 MPEG 的音響設備上時選擇此項設定。
如果本機並未連接支援 MPEG 的音響設備，請勿將本選項設定「開」。假如您選擇錯誤，在播放支援 MPEG 的光碟時，喇叭會發出刺耳的劇烈雜音 (或發不出聲音)，更可能會損壞到您的耳朵及喇叭。
- 關**：當本機連接的音響設備並未支援 MPEG 時選擇此項設定。

■ 聲音軌跡自動選擇模式

播放錄有多種音頻信號 (PCM、Dolby Digital 或 DTS) 或者 MPEG AUDIO 信號的 DVD 時，本機的 DVD 播放系統將主動選擇最高音質 (音頻符號最多) 的音軌進行播放。

在選擇重續播放時，將無法使用或設定本功能。

- 開**：優先選擇。
- 關**：不需優先選擇。

注意事項

- 若將本項目設定為「開」，可能會造成聲音語言遭到強制改變。這是因為「聲音軌跡自動選擇模式」的設定優先於「語言設定」選單中的「聲音語言」設定。(參考第 23 頁的說明)
- 如果您在「聲音設定」選單下，將「DIGITAL OUT (OPTICAL)」項目設定為「開」而「DTS」卻設定為「關」，那麼即使將「聲音軌跡自動選擇模式」設定為「開」，亦無法自動播放音頻信號最多的 DTS 信號。
- PCM、DTS、Dolby Digital (杜比數碼 AC-3)，以及 MPEG 信號的音頻信號數都相同的情形，那麼本機會依照 PCM、Dolby Digital (杜比數碼 AC-3)、DTS、MPEG 的音軌順序開始播放。
- 某些 DVD 的信號優先播放順序是固定的。在播放這類 DVD 時，您無法透過將「聲音軌跡自動選擇模式」設定為「開」來優先播放 DTS、Dolby Digital (杜比數碼 AC-3) 或 MPEG 信號。

■ DVD 音量

假如 DVD 音量的輸出功率過低，您可以選擇調整 DVD 音量。改變設定時必須先將「DIGITAL OUT (OPTICAL)」(數碼輸出光纖)設定為「關」。

- +2：調高音量。(最大音量)
- +1：調高音量。
- 標準：正常音量。通常選擇此項設定。

注意事項

某些 DVD 在選擇「+1」、「+2」後，會出現音質失真的現象。若出現這種情況，請選擇「標準」設定。

警告

如果您將音量調得過高，可能會傷害耳朵或損壞接收器(放大機)。

本機採用的著作權保護技術乃是受美國專利權及智慧財產權(知識產權)等相關法律保護，由 Macrovision 和其他著作權人共同保有之認證技術。非經 Macrovision 正式許可，禁止擅自使用。未獲得 Macrovision 特殊授權，嚴禁在一般家庭等視聽觀賞用途以外的地方使用。禁止自行拆卸或分解本機。



在使用 PlayStation®2 主機時，如果操作上遭遇到困難，請閱讀下面的文章，以便找到問題的可能原因。

- ① 如果您遭遇到下列困難，請閱讀以下的故障檢修指南，以方便您解決問題或恢復正常操作。如果無法解決問題，請就近與保證書上記載的消費者服務中心聯繫。
- ② 請檢查交流電源線是否正確連接在主機上，插頭並確實插在牆壁插座上。同時也檢查電視機（錄影機）或其他周邊設備的連接方法是否有任何錯誤不當的地方。

電源

無法接通電源

- ➔ 確認交流電源線是否正確連接。
- ➔ 主機是否沒有打開電源。請按主機背面的 MAIN POWER（主電源）按鈕，接通電源。

畫面

無畫面

- ➔ 檢查是否已用 AV 連接線（音頻／視頻一體化）將本機正確連接在電視機（或錄影機）上。
- ➔ 確認主機及電視機（或錄影機）都已經接通電源。
- ➔ 確認已經替電視機設定正確的影像輸入頻道。
- ➔ AV 連接線（音頻／視頻一體化）的端子是否並沒有牢靠插入。
- ➔ 確認您放入的是一片本機可以對應的光碟（請參考第 3 頁的說明）。
- ➔ 確認放入光碟時，標籤之面是否朝上（播放面朝下）。

- ➔ 光碟未正確放入托盤。
- ➔ 主機是否被設定在暫停狀態。
- ➔ 嘗試用其他 AV 連接線連接。
- ➔ 未使用支援逐行掃描的電視機，或者使用非 PlayStation®2 專用影像色差連接線時，將「Progressive」（逐行掃描）設定為「關」了。
請不要打開光碟托盤或退出 DVD。在 DVD 放入主機內的狀態下，按主機前面的 ⏻（預備）／RESET（再啟動）按鈕，然後按住類比控制器（DUALSHOCK®2）的 START（開始）按鈕，直至顯示 DVD 畫面。若 DVD 開始播放，則代表「Progressive」將被設定為「關」，並將顯示出圖像。您也可選擇版本畫面將「Progressive」（逐行掃描）設定為「關」。詳細內容請參閱第 9 頁。

畫面出現雜痕

- ➔ 擦拭光碟。
- ➔ 主機因濕氣過重而結露（參考第 2 頁）
- ➔ 是否把主機放在不穩定的地方。請把主機放置在平穩地方後使用。並切勿搖晃或震動主機。
- ➔ 當從主機發出的影像信號透過錄影機傳送到電視機時，防盜版技術誤導致某些 DVD 影像失真。當播放 DVD 時，請把主機直接連接到電視機上。（參考第 6 頁的說明）
- ➔ 未使用支援逐行掃描的電視機，或者使用非 PlayStation®2 專用影像色差連接線時，將「Progressive」（逐行掃描）設定為「關」了。
請不要打開光碟托盤或退出 DVD。在 DVD 放入主機內的狀態下，按主機前面的 ⏻（預備）／RESET（再啟動）按鈕，然後按住類比控制器（DUALSHOCK®2）的 START（開始）按鈕，直至顯示 DVD 畫面。若 DVD 開始播放，則代表「Progressive」將被設定為「關」，並將顯示出圖像。您也可選擇版本畫面將「Progressive」（逐行掃描）設定為「關」。詳細內容請參閱第 9 頁。

- ➔ 即使所使用的電視機支援逐行掃描，在以逐行掃描方式播放時，有些影像顯得不自然。
請將「Progressive」（逐行掃描）設定為「關」，然後選擇隔行掃描方式觀看。

當播放寬螢幕畫面的 DVD 時，無法配合電視機規格變更螢幕尺寸

- ➔ 某些 DVD 的螢幕尺寸是事先被固定的。
- ➔ 確認主機已經直接連接在電視機上。（請不要在主機及電視機之間連接選台器或接收器（擴大機）
- ➔ 某些電視機的螢幕尺寸是固定、無法修改的。

播放以 VR 模式錄製的 DVD-RW 光碟時，畫面上出現「播放功能受到限制，無法進行播放。」的字句，然後畫面變成一片藍色。

- ➔ 您正在播放的光碟可能包含「只能複製一次」的內容。利用「只能複製一次」之功能錄製的，支援 CPRM 的 DVD-RW 光碟上的影像是無法進行播放的。詳細內容請參閱第 3 頁的「播放 DVD-R/DVD-RW/DVD+R/DVD+RW 光碟的注意事項」。

聲音

無聲

- ➔ 檢查是否已用 AV 連接線（音頻／視頻一體化）將本機正確連接在電視機（或錄影機）上。
- ➔ 確認主機及電視機（或錄影機）都已經接通電源。
- ➔ 確認已經替電視機設定正確的影像輸入頻道。
- ➔ 確認音量是否適中及是否按了「靜音」按鈕。
- ➔ 確認 AV 連接線（音頻／視頻一體化）的端子是否並沒有牢靠插入。
- ➔ 確認放入的是本機可以對應的光碟。（請參考第 3 頁的說明）。
- ➔ 確認放入光碟時，標籤之面是否朝上（播放面朝下）。

- ➔ 檢查主機及接收器（擴大機）間，AV 連接線（音頻／視頻一體化）的連接是否正確。
- ➔ 嘗試用其他 AV 連接線連接。
- ➔ 檢查喇叭的連接和設定。
請同時參閱喇叭的使用說明書。
- ➔ 檢查您是否在接收器（擴大機）上選擇了適當的輸入頻道。請同時參閱接收器（擴大機）的使用說明書。
- ➔ 主機被設定在暫停狀態。
- ➔ 主機正在執行尋找或慢動作播放（當播放 DVD 時）
- ➔ 您正在播放 DTS 音軌的音樂 CD 或 DVD 光碟。
當主機連接的是不帶內建 DTS 解碼器的音響設備時，請不要播放 DTS 音軌。（請參閱第 23 頁。）
- ➔ 當主機連接支援 DIGITAL OUT (OPTICAL)（數碼輸出光纖）的音響設備時，未正確修改系統設定。（參考第 6 頁的說明）

音質不良

- ➔ 擦拭光碟。
- ➔ 把主機放在不穩定的地方。
請把主機放置在平穩地方後使用。並切勿搖晃或震動主機。
- ➔ 主機因濕氣過重而結露。（參考第 2 頁的說明）
- ➔ 正在播放支援 DTS 的 CD 或 DVD 光碟。
主機必須要先連接一套內建 DTS 解碼器的音響設備，才能夠順利播放支援 DTS 的光碟。

播放支援 Dolby Digital（杜比數碼 AC-3）的 DVD（數碼影音光碟）時，很難享受到環繞音效的震撼臨場感

- ➔ 檢查喇叭的連接和設定。
請同時參閱喇叭的使用說明書。
- ➔ 某些 DVD 即使支援 Dolby Digital（杜比數碼 AC-3），但信號的輸出傳送仍可能並未採用完全的 5.1 聲道，而或許是單聲道或立體聲。

只能聽到中置喇叭的聲音

- ➔ 某些光碟的聲音可能只能從中置喇叭發出。

操作**無法操縱控制器**

- ➔ 確認控制器是否正確連接在主機上。
- ➔ 確認類比控制器 (DUALSHOCK®2) 的操作模式是否已配合軟件正確設定。(參考第 11 頁的說明)
- ➔ 嘗試用其他控制器重新操作。

無法啟動軟件

- ➔ 確認您放入的是一片本機可以對應的光碟。(請參考第 3 頁的說明)
- ➔ 確認放入光碟時，標籤之面是否朝上(播放面朝下)。
- ➔ 光碟未正確放入托盤。
- ➔ 是否有結露現象。(參考第 2 頁的說明)
- ➔ 擦拭光碟。
- ➔ 嘗試啟動其他光碟。
- ➔ 確認是否已對正在播放的 DVD-R 或 DVD-RW 進行了最終化操作。

無法將遊戲資料保存到 PlayStation®2 專用 MEMORY CARD (記憶卡) (8MB) 或 MEMORY CARD (記憶卡)

- ➔ 確認 PlayStation®2 專用 MEMORY CARD (記憶卡) (8MB) 或 MEMORY CARD (記憶卡) 是否已經插在主機上。
- ➔ 確認您是否依遊戲指示正確操作。請同時參閱遊戲說明書。
- ➔ 確認 PlayStation®2 專用 MEMORY CARD (記憶卡) (8MB) 或 MEMORY CARD (記憶卡) 內尚有足夠的空白記憶體。
- ➔ 嘗試用其他 PlayStation®2 專用 MEMORY CARD (記憶卡) (8MB) 或 MEMORY CARD (記憶卡) 再度執行保存。

主機無法正確動作

- ➔ 靜電等的發生可能影響主機的內部電路而導致動作出現異常。請按 MAIN POWER (主電源) 按鈕關閉本機電源，然後再重新接通。

顯示燈閃爍紅燈，且無法操作主機

- ➔ 顯示燈閃爍紅燈代表目前主機出現「錯誤」而無法操作。請清除堆積在通風孔的污垢後將本機搬到涼爽的地方降低機內溫度。等本機恢復到預備狀態後才重新使用。

無法打開光碟托盤

- ➔ 確認交流電源線是否正確連接。
- ➔ 主機是否沒有打開電源。請按主機背面的 MAIN POWER (主電源) 按鈕，接通電源。

DVD 光碟的操作**播放 DVD 光碟時，主機無法從開頭開始播放**

- ➔ 已選擇重續播放。開始播放前，請選擇 ■ (停止) 圖標後按兩次 × 按鈕。(請參閱第 16 頁。)
- ➔ 某些光碟在選擇播放會自動先顯示標題選單或 DVD 選單。

即使選擇了 DVD 標題亦無法開始播放

- ➔ 視聽年齡限制機能禁止該光碟的播放。

自動停止播放

- ➔ 光碟可能設定了自動暫停。當播放這類光碟時，本機會自設定的信號點起停止播放。

無法進行停止、尋找、慢動作播放、編序播放、隨機播放或重複播放等操作。

- ➔ 某些光碟可能無法執行上述操作。

無法改變聲音軌跡語言。

- ➔ 該片 DVD 並未錄製多種聲音語言可供選擇。
- ➔ 您播放的是一片禁止變更聲音語言的 DVD。

無法改變字幕語言

- ➔ 該片 DVD 並未錄製多種字幕可供選擇。
- ➔ 您播放的是一片禁止變更字幕的 DVD。

無法隱藏字幕

- ➔ 某些 DVD 可能無法選擇隱藏字幕。

當播放 DVD 時，無法改變角度

- ➔ 該片 DVD 並未錄製多種角度(多角度)可供選擇。
- ➔ 您播放的是一片禁止變更角度的 DVD。

無法選擇 **PLIST 圖標**

- ➔ 請將 DVD-RW (VR 模式) 光碟放入主機。(請參閱第 18 頁。)

一般規格

電源	220 - 240 V AC, 50 Hz
功率消耗	50 W
尺寸 (大約)	301 × 78 × 182 mm (寬 × 高 × 深)
重量 (大約)	2.0 kg
操作溫度	5°C - 35°C
激光二極管比率	<ul style="list-style-type: none"> • 材料: GaAlAs • 波長: λ=650/780 nm

主機前面的輸入/輸出

控制器端子 (2)
MEMORY CARD (記憶卡) 插口 (2)
ψ USB 連接埠 (2)

主機背面的輸入/輸出

AV MULTI OUT (AV 多重輸出) 端子 (1)
DIGITAL OUT (OPTICAL) (數碼輸出光纖) 端子 (1)
EXPANSION BAY (擴充槽) (1)

附屬品

參考第 4 頁的說明。

選購品

SCPH-10010 G	類比控制器 (DUALSHOCK®2)
SCPH-10020 G	PlayStation®2 專用 MEMORY CARD (記憶卡) (8MB)
SCPH-10040 G	PlayStation®2 專用直立式 S 視頻連接線
SCPH-10060 G	PlayStation®2 專用 (對戰) 多重連接器
SCPH-10090 G	PlayStation®2 專用影像色差連接線
SCPH-10110 G	PlayStation®2 專用橫放架
SCPH-10420 G	PlayStation®2 專用 DVD 遙控器
SCPH-1020 HI	MEMORY CARD (記憶卡)
SCPH-110	類比控制器 (DUALSHOCK®)

本公司保留在不予通知情況下，變更設計或規格之權利。

章 (參考第 19 頁)

DVD 中所使用的，電影或音樂的收錄單位，可收錄時間比「標題」短。一個「標題」大致被分為數個「章」。每個章都有所謂的「章號碼」，以方便您選擇想要播放的章。

Dolby Digital (杜比數碼 AC-3) (參考第 7 頁、第 23 頁)

由杜比實驗室開發的數碼聲音壓縮技術。此技術支援 5.1 聲道環繞音效。採用此格式時，後置喇叭為立體聲，並另外分離出低音喇叭聲道。透過杜比數碼 (AC-3) 影院音響系統，杜比數碼 (AC-3) 可提供具備相當高品質數碼聲音的 5.1 分離聲道。因為所有聲道的信號數據完全分離錄製並以數碼方式處理，所以能實現良好的聲道分離效果。

DTS (參考第 7 頁、第 23 頁)

由杜比實驗室開發的數碼聲音壓縮技術。此技術支援 5.1 聲道環繞音效。採用此格式時，後置喇叭為立體聲，並另外分離出低音喇叭聲道。DTS 可提供具備相當高品質數碼聲音的 5.1 分離聲道。因為所有聲道的信號數據完全分離錄製並以數碼方式處理，所以能實現良好的聲道分離效果。

DVD (參考第 14 頁)

大小和音樂 CD 相同，最高可存放 8 小時高畫質動態影片的高密度光學光碟。

單層單面的 DVD 的儲存容量為 4.7GB，相當於普通 CD 的 7 倍容量。而雙層單面的 DVD 容量為 8.5GB；單層雙面 DVD 為 9.4GB；雙層雙面則為 17GB。

畫面採用數碼壓縮技術的世界標準之一的 MPEG 2 格式，可將圖像壓縮成原先容量的 1/40。此外還採用了依照圖像的狀況而改變數據壓縮比的可變速率編碼技術。

在音效上更支援了杜比數碼 AC-3 環繞音效及 DTS，讓您可在家中欣賞到更逼真的環繞音效。

另外，DVD 還具備多重角度 (多角度)、多重語言及視聽年齡限制等多樣的先進功能。

DVD-RW

DVD-RW 是和 DVD VIDEO 光碟尺寸相同的可讀寫光碟。DVD-RW 能以兩種模式錄製：VR 模式和視頻模式。

- 視頻模式—兼容 DVD-VIDEO 規格，經最終化處理後，大多數的 DVD 播放機都可播放其收錄之內容。但以 VR 模式錄製的 DVD-RW 則只能使用對應 DVD-RW 的 DVD 播放機播放。
- VR (視頻錄製) 模式—可以使用選擇視頻模式時無法使用的各種編序和編輯功能。

DVD+RW

DVD+RW (念「加 RW」) 是可讀寫光碟。DVD+RW 光碟採用了對應 DVD 視頻格式的錄製格式。

DVD 圖像素材

DVD 圖像素材可分為兩類：視頻來源的素材和電影來源的素材。視頻來源的素材以每秒 30 幀 (60 場) 的速率錄製，一般指各種電視節目。電影來源的素材以每秒 24 幀的速率錄製，大多數電影底片屬於這一類。有些 DVD 既錄有視頻來源的素材，又錄有電影來源的素材。

MPEG 聲音格式 (參考第 23 頁)

由 ISO/IEC 制定的，用於壓縮數位 (數碼) 聲音信號的國際標準檔案格式。

多重角度 (多角度) (參考第 18 頁)

某些 DVD 會在同一個場景上錄製多種角度 (攝影機角度)。

多語言功能 (第 18、20 頁)

某些 DVD 會準備多種的聲音語言及字幕語言。

視聽者年齡限制 (第 21 頁)

根據各國對各年齡層的影像播放標準而限制 DVD 播放機能的一項特殊技術。當有效起動此功能時，光碟的播放會因為光碟內容而出現無法播放、刪除暴力場景或用其他畫面代替的情形。

逐行掃描 (第 21 頁)

與通過交替掃描各行來顯示一幀圖像的隔行方式相比，逐行掃描一次刷新就能顯示完整的一幀圖像，即隔行方式每秒可以顯示 30 幀，而逐行掃描每秒則可以顯示 60 幀。通過逐行掃描可以提高整體圖像的質量，而且使靜像、文字和水平線顯得更鮮明。

標題 (參考第 18 頁)

不論是為收錄電影等影像信號的影音光碟或為收錄專輯等音樂信號的音樂光碟，在 DVD 中，電影或音樂的收錄最長單位。每個標題都有所謂的「標題號碼」，以方便您選擇想要播放的標題。

請參考附在主機盒內，適用各國家、各地區，接受保證維修前的必要保證書。



“”, “PlayStation”, “DUALSHOCK” and “ $\Delta \times \square$ ” are registered trademarks and “” is a trademark of Sony Computer Entertainment Inc. “SONY” is a registered trademark and “” and **MAGICGATE** are trademarks of Sony Corporation.

“”、“PlayStation”、“DUALSHOCK”和“ $\Delta \times \square$ ”為 Sony Computer Entertainment Inc. 之註冊商標。

“”則為該公司之商標。

“SONY”為 Sony Corporation 之註冊商標。“”和“**MAGICGATE**”則為該公司之商標。